

Slip distribution of the 2011 Tohoku-oki earthquake

Yuichiro Tanioka and Aditya R. Gusman
(Hokkaido University)

Observation points of tsunami waveforms

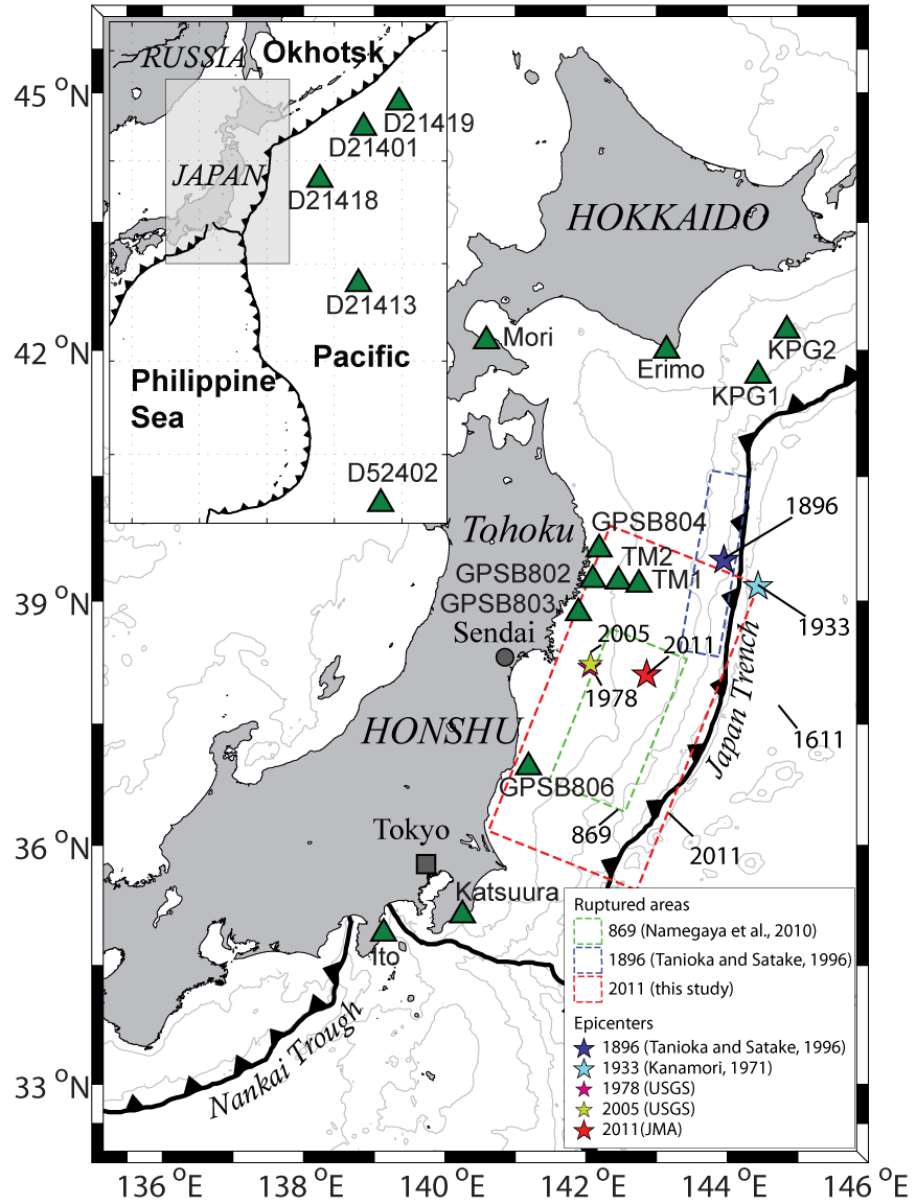

Aftershock distribution and subfaults for the joint inversion

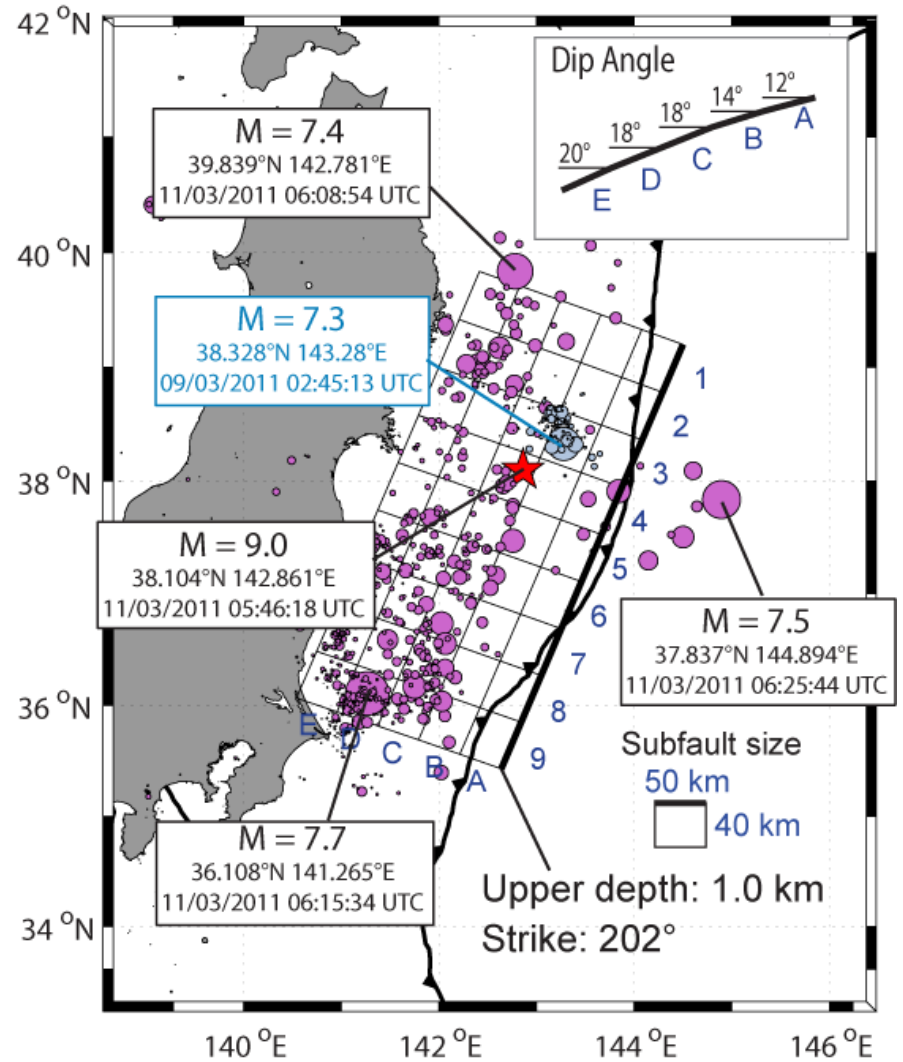

Ocean bottom pressure gauges off Kushiro (JAMSTEC)

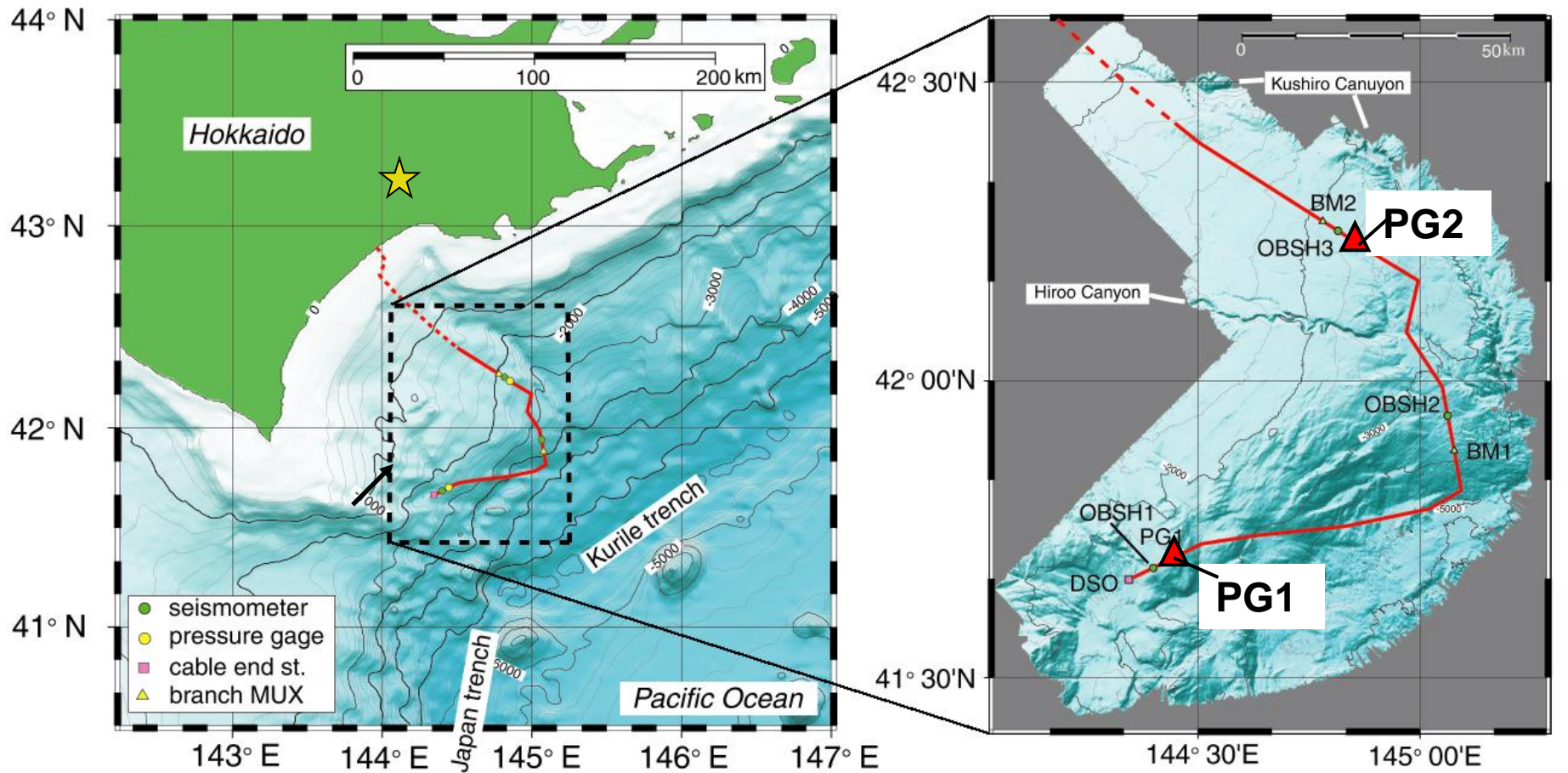

Ocean bottom pressure gauge with a cable system

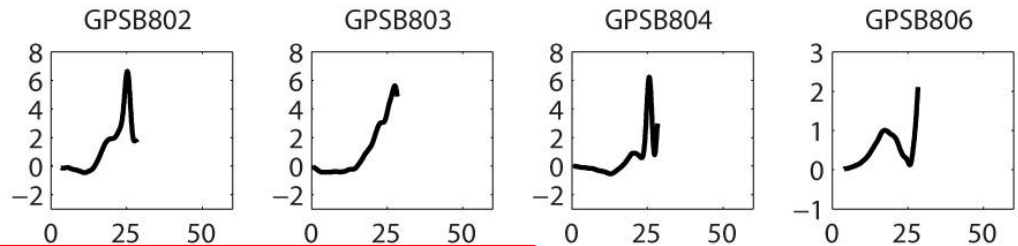

Kamaishi-oki

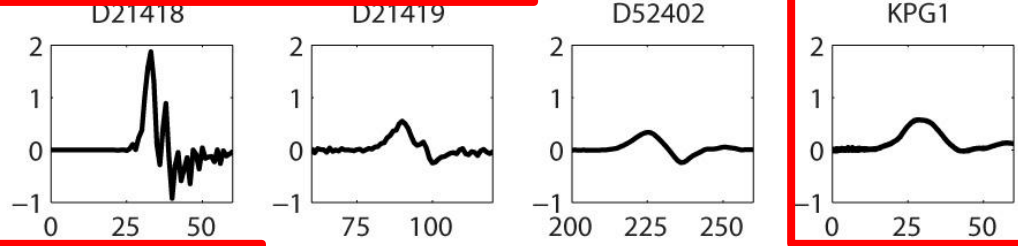
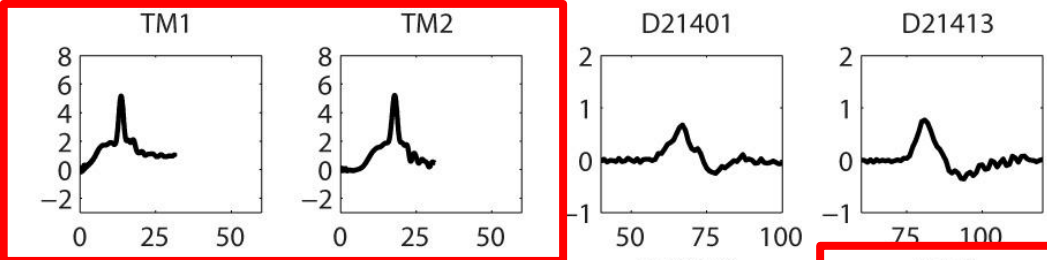

Kushiro-oki

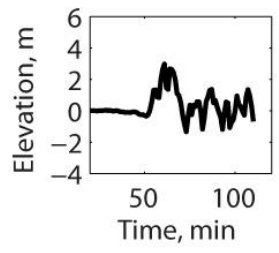
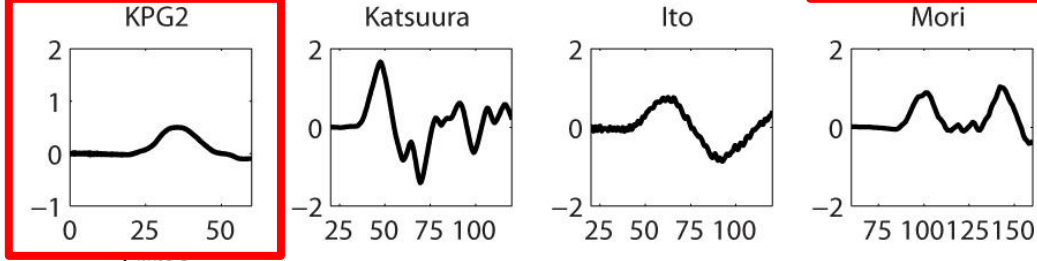

— Observed tsunami

GPS Tsunami meter (Port and Airport Research Institute)



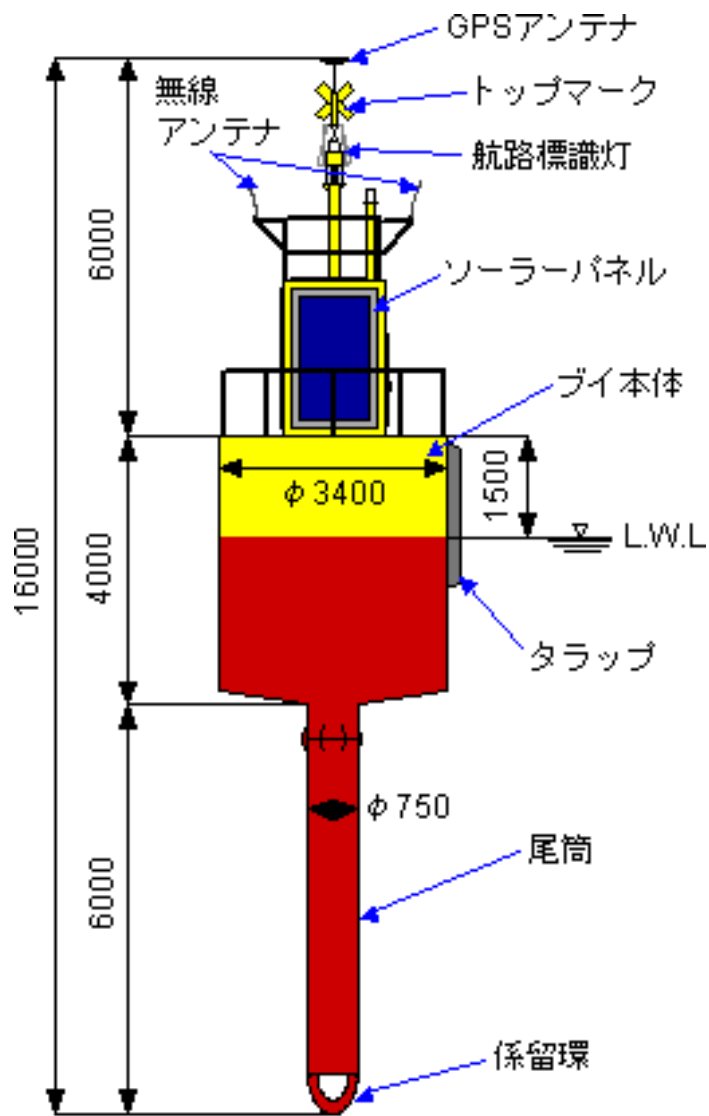

GPS津波計観測ブイ概略

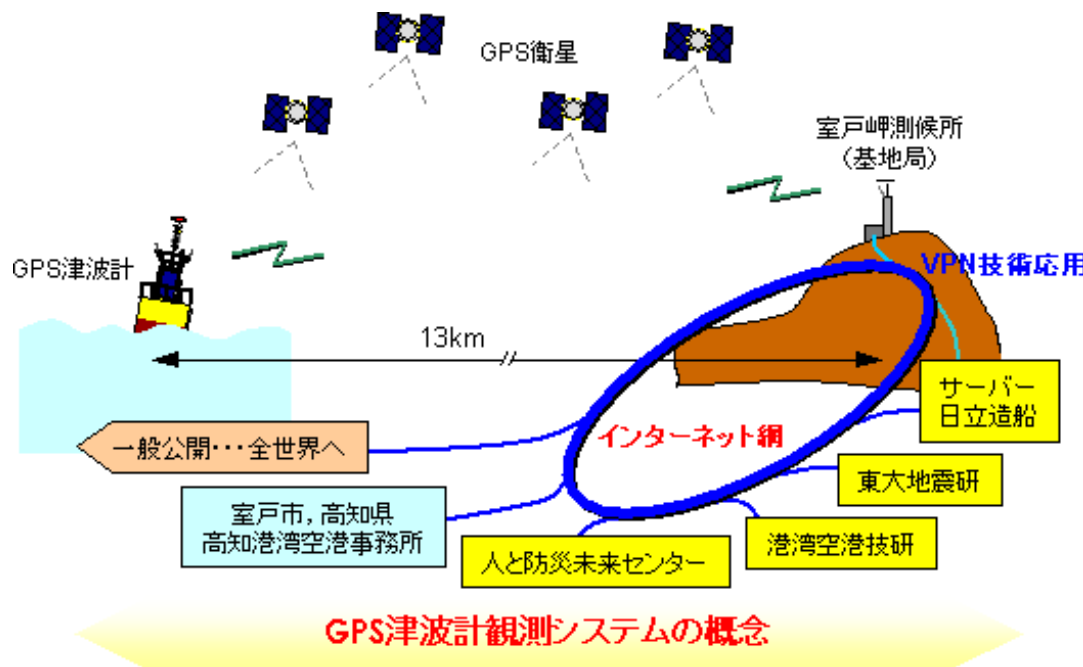

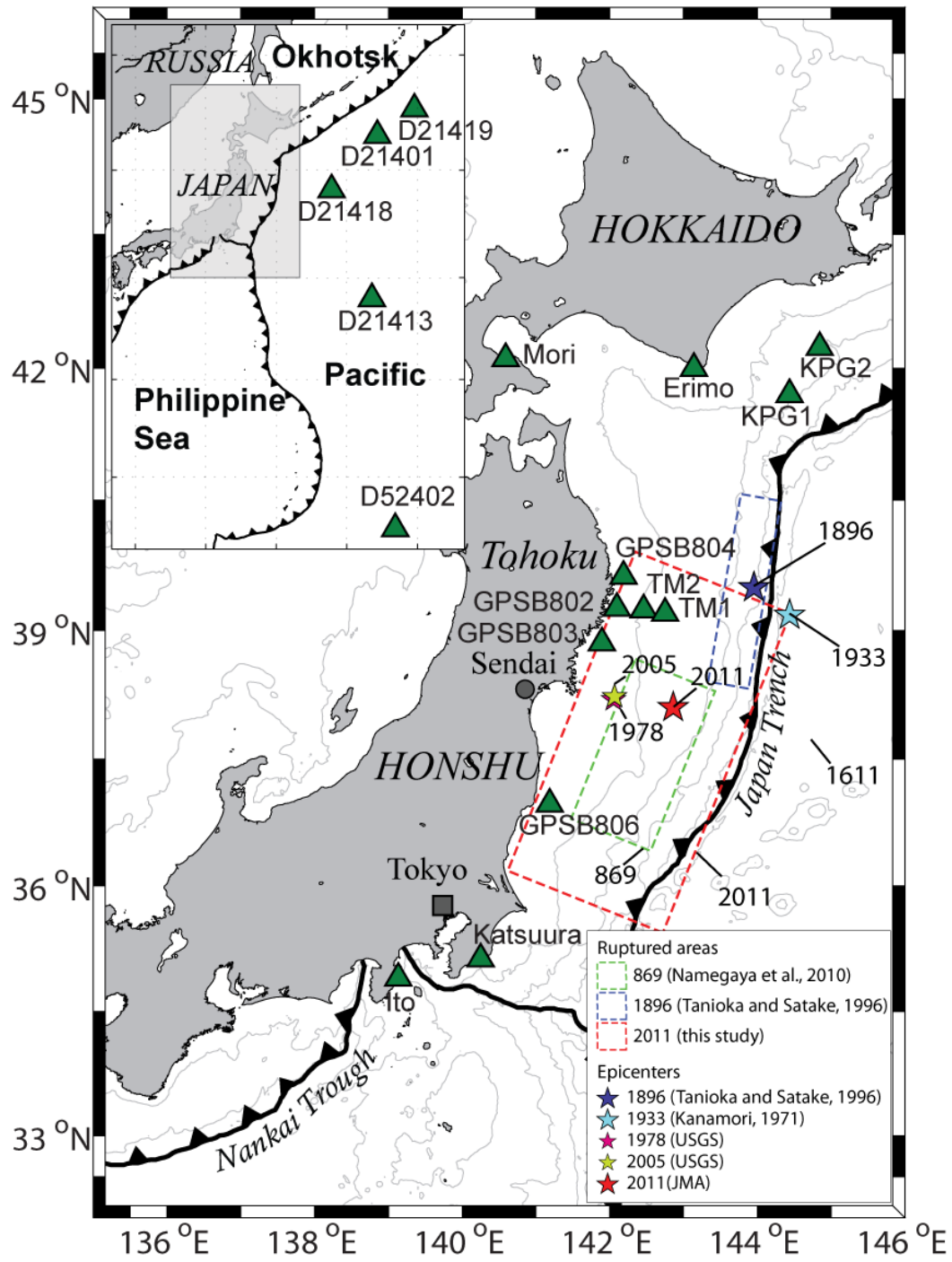

GPS Tsunami
meters

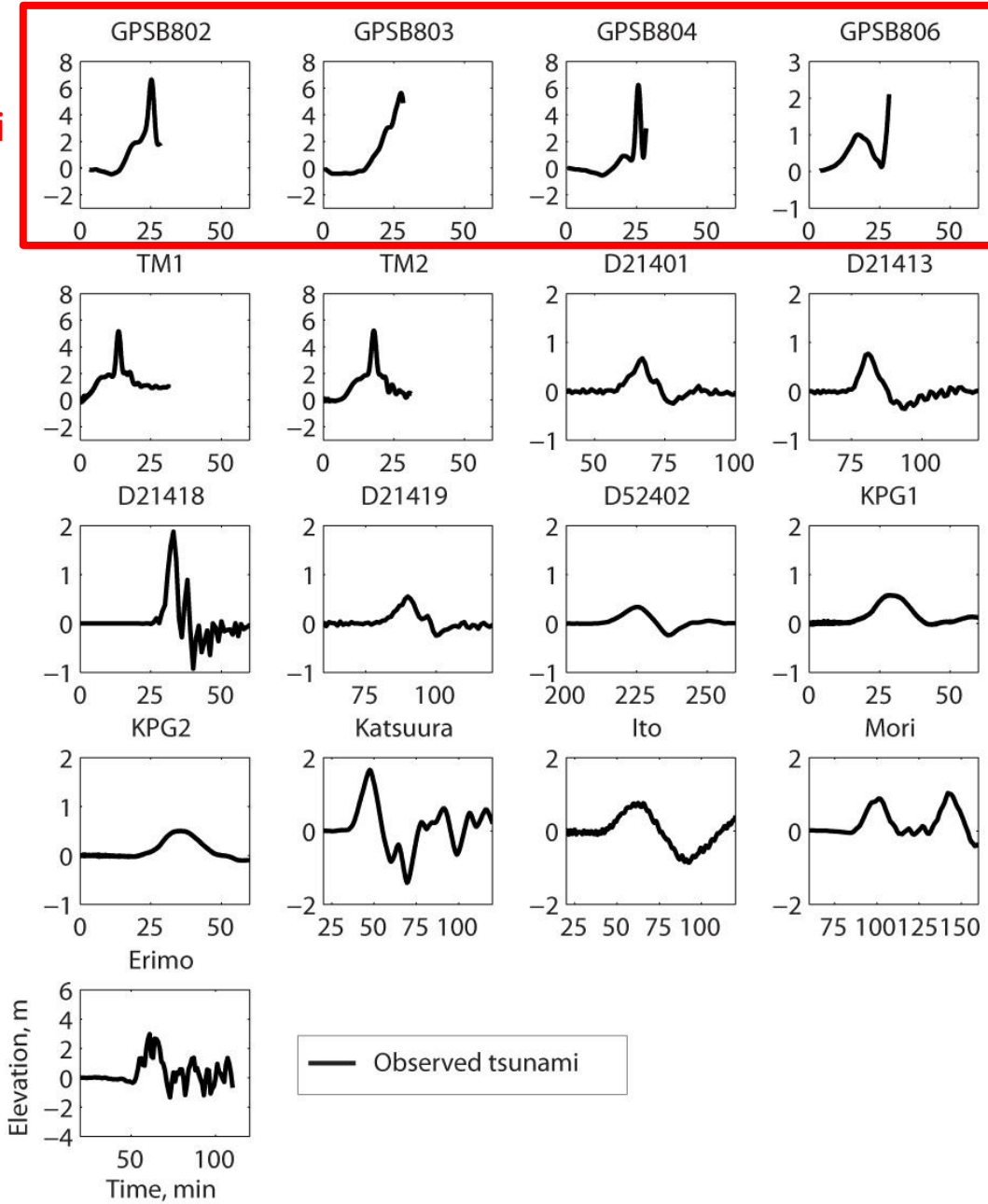

DART Mooring System

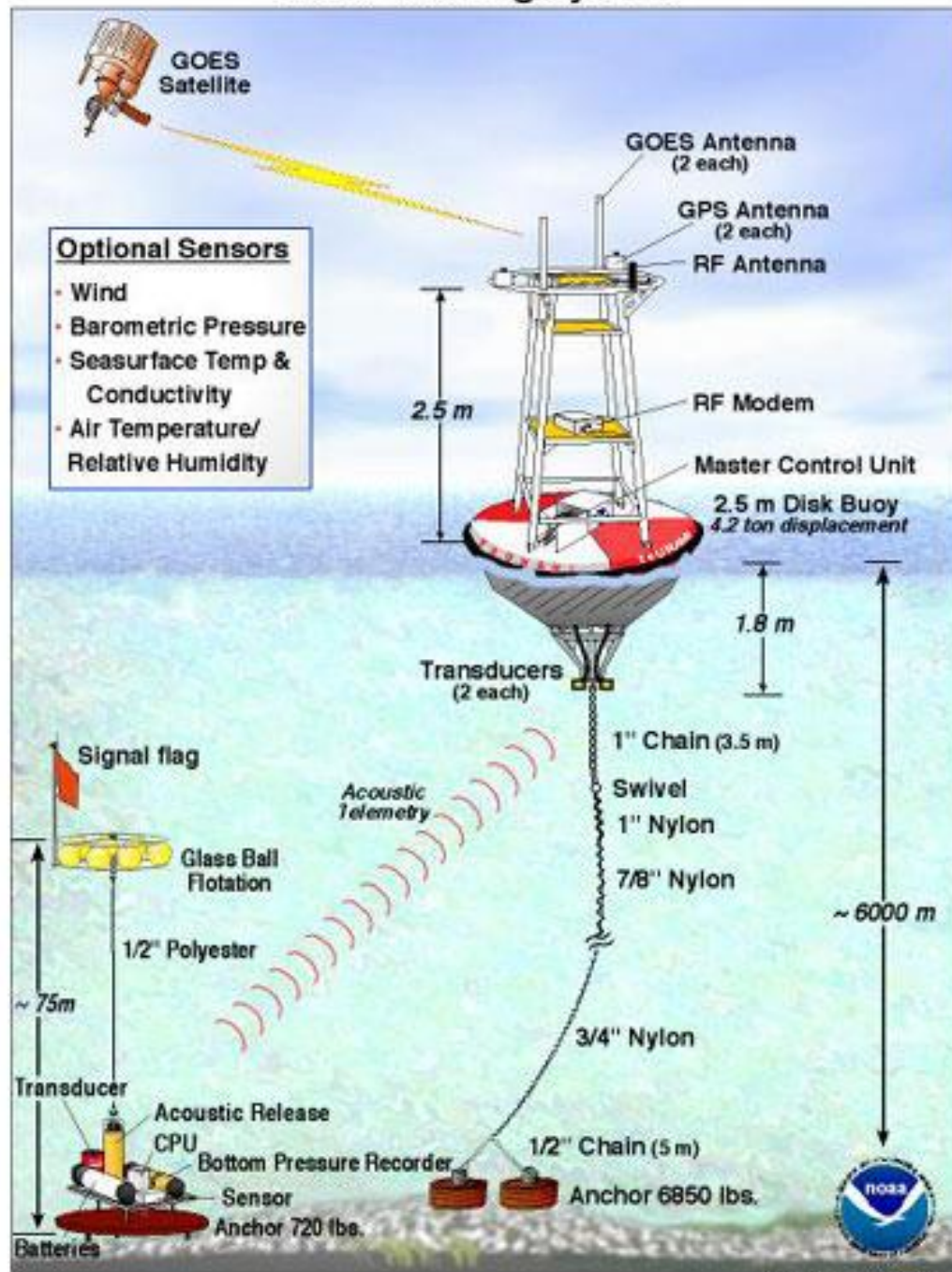

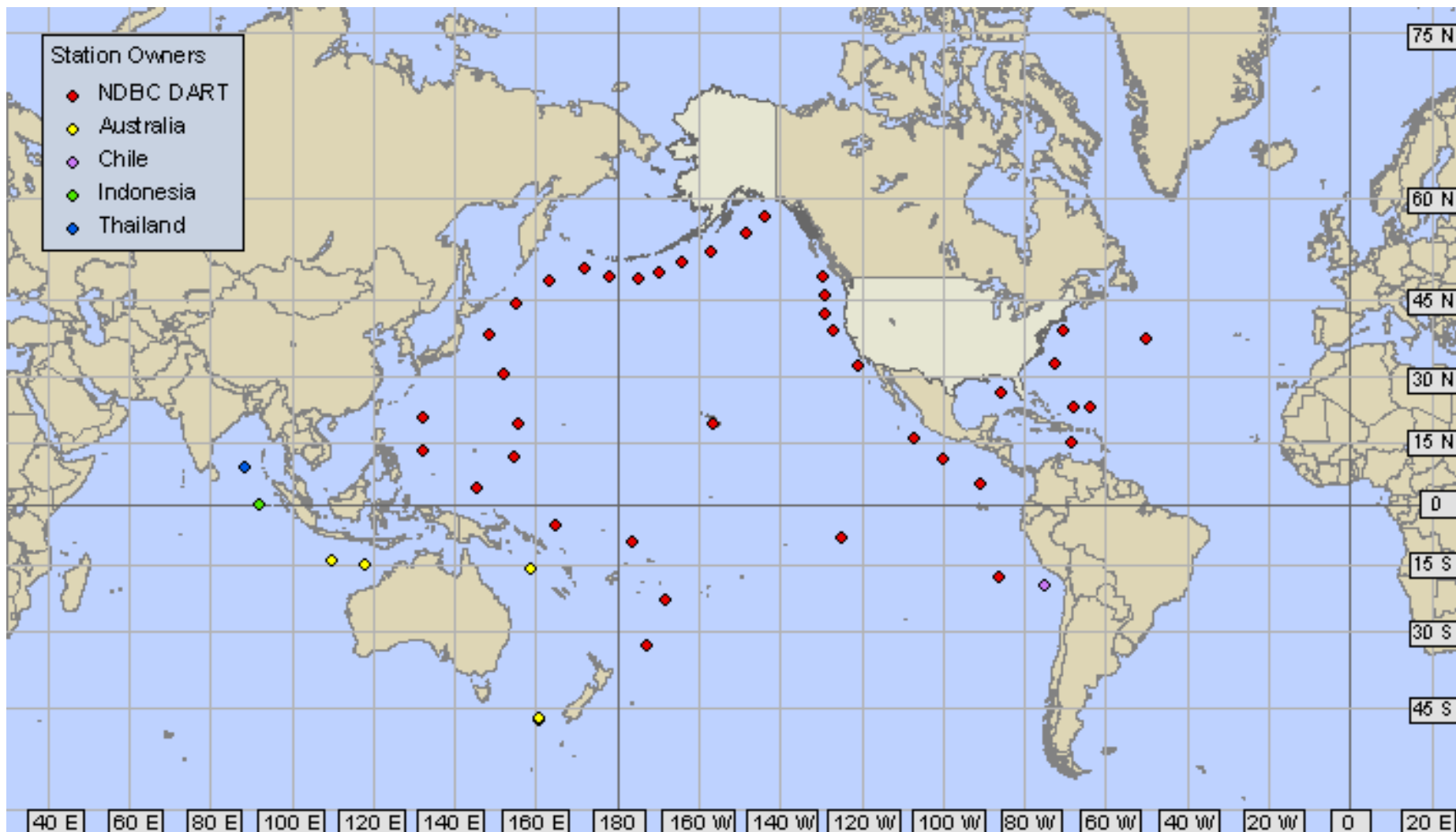

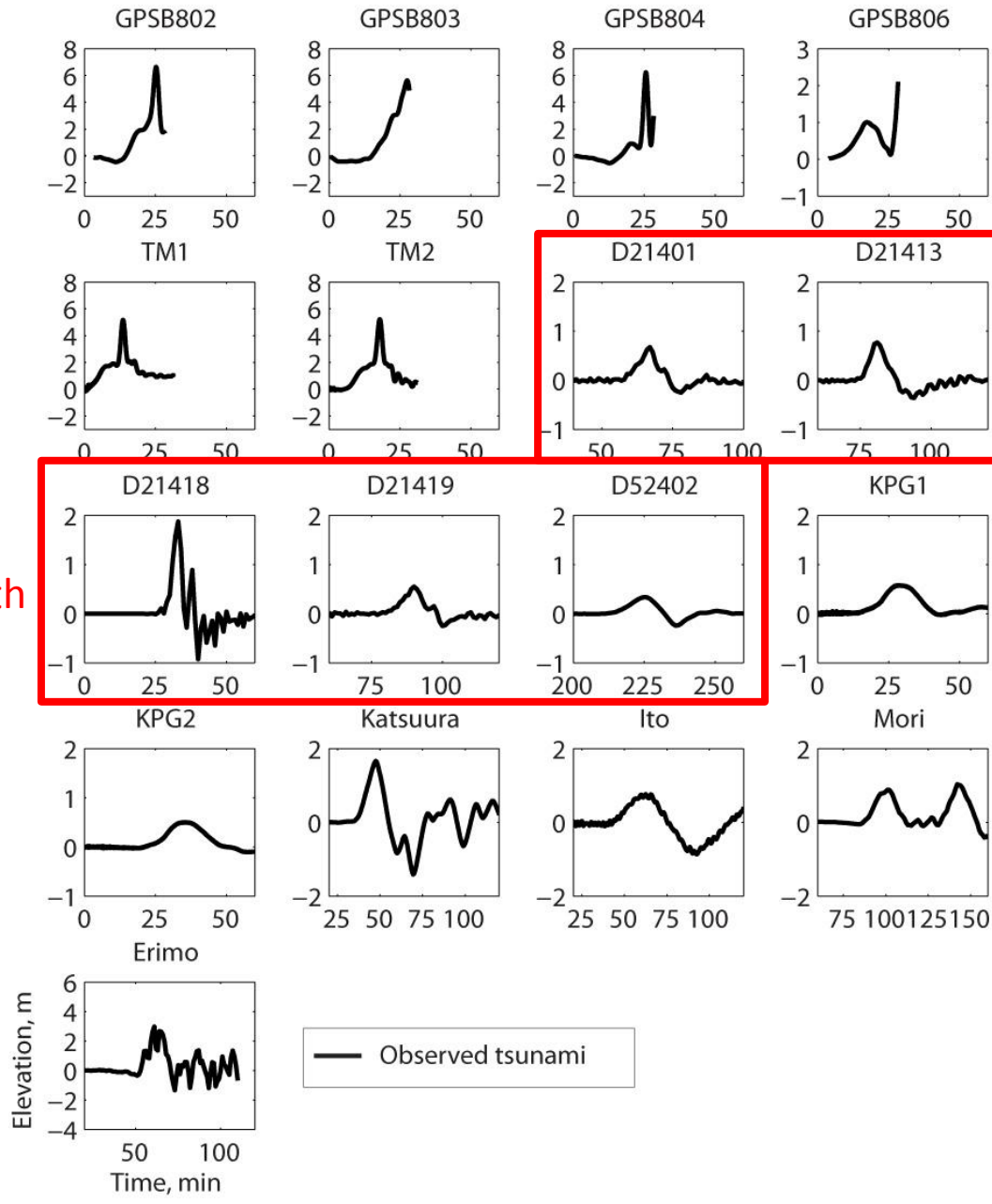

Ocean bottom pressure gauges with buoys (DART)

Slip distribution estimated using the joint inversion of co-seismic crustal deformation and

a) tsunami waveforms

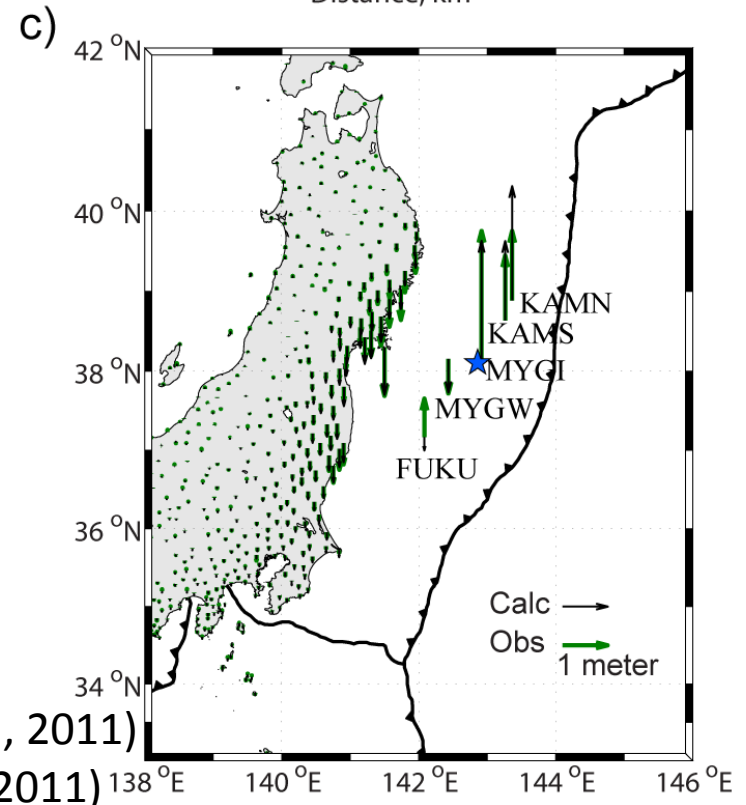
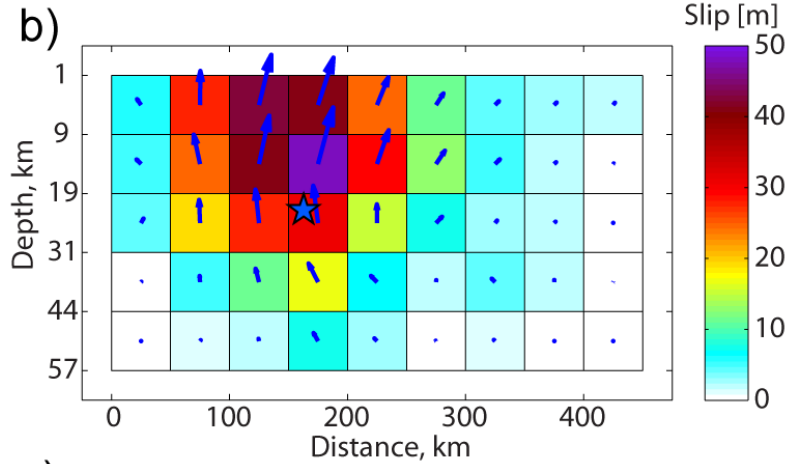
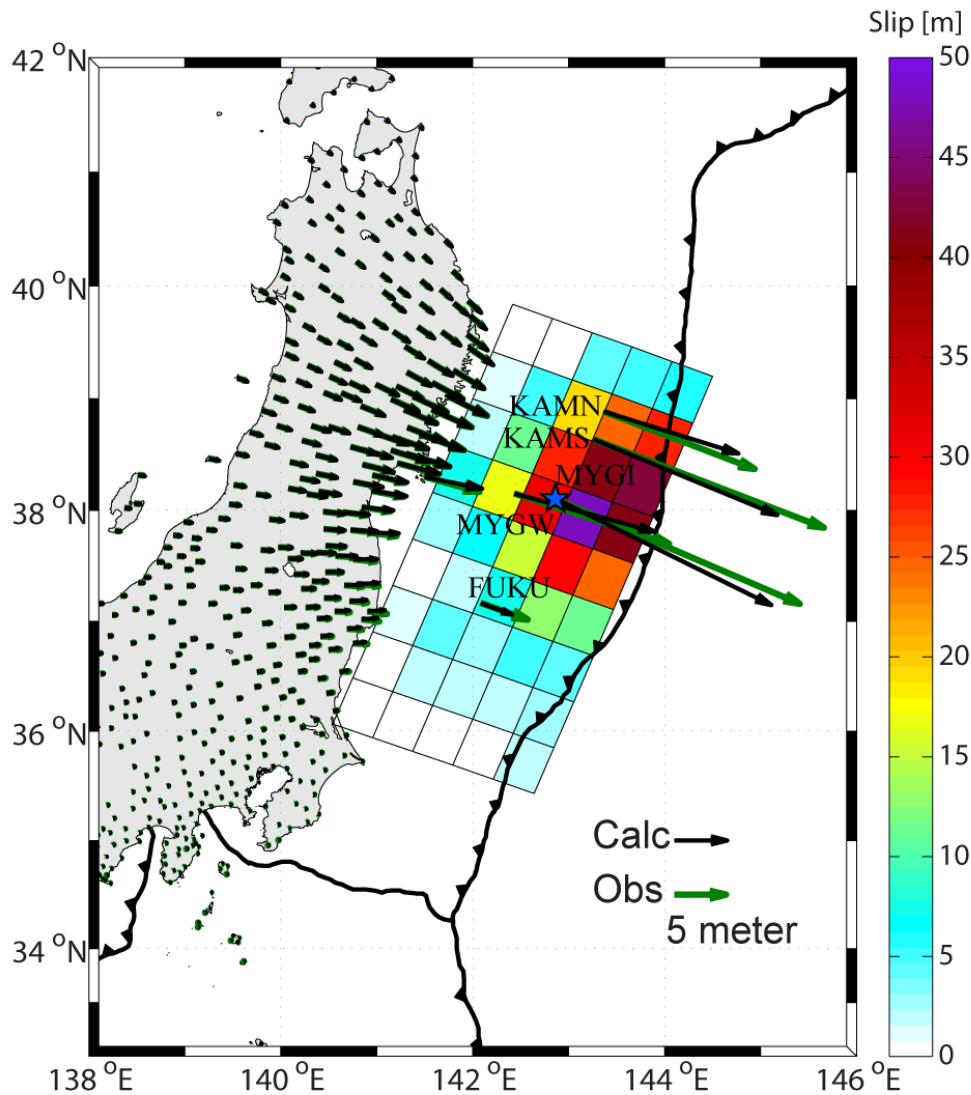

Co-seismic deformation observed by GPS (Ozawa et al., 2011)

Co-seismic deformation at ocean bottom (Sato et al., 2011)

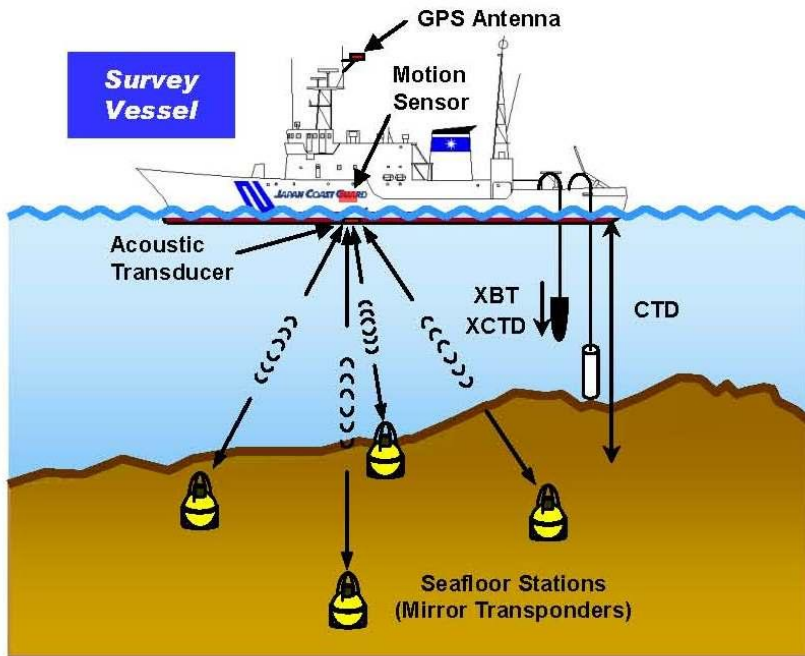

Ocean Bottom Crustal Deformation Observation

Sato et al. (Science 2011)

(A) Horizontal displacements

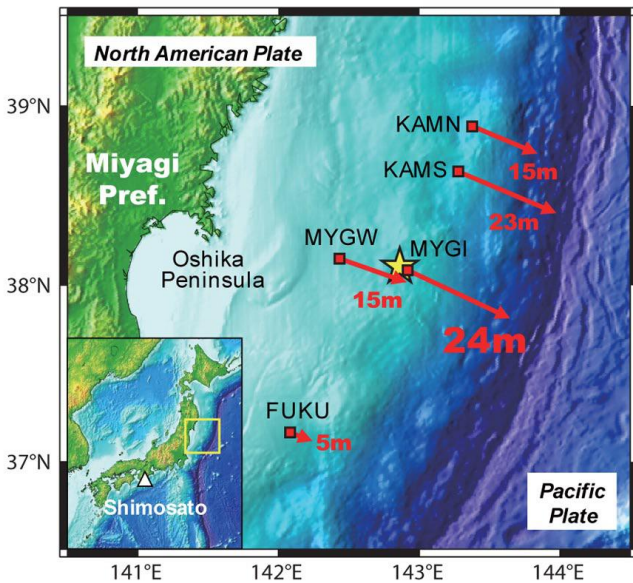

(B) Vertical displacements

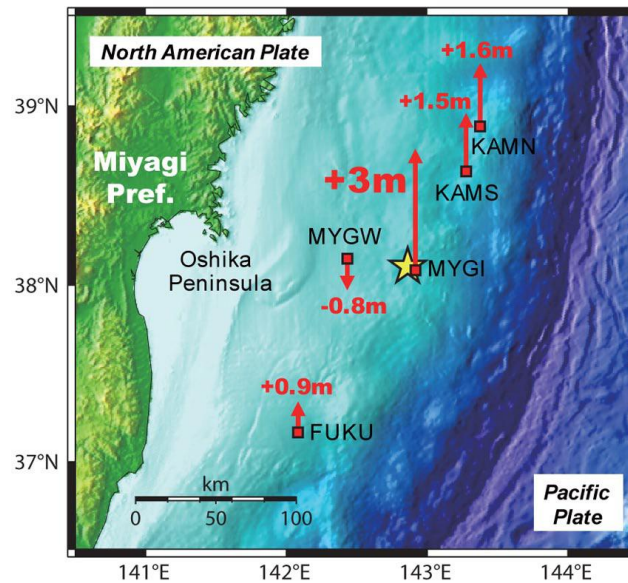

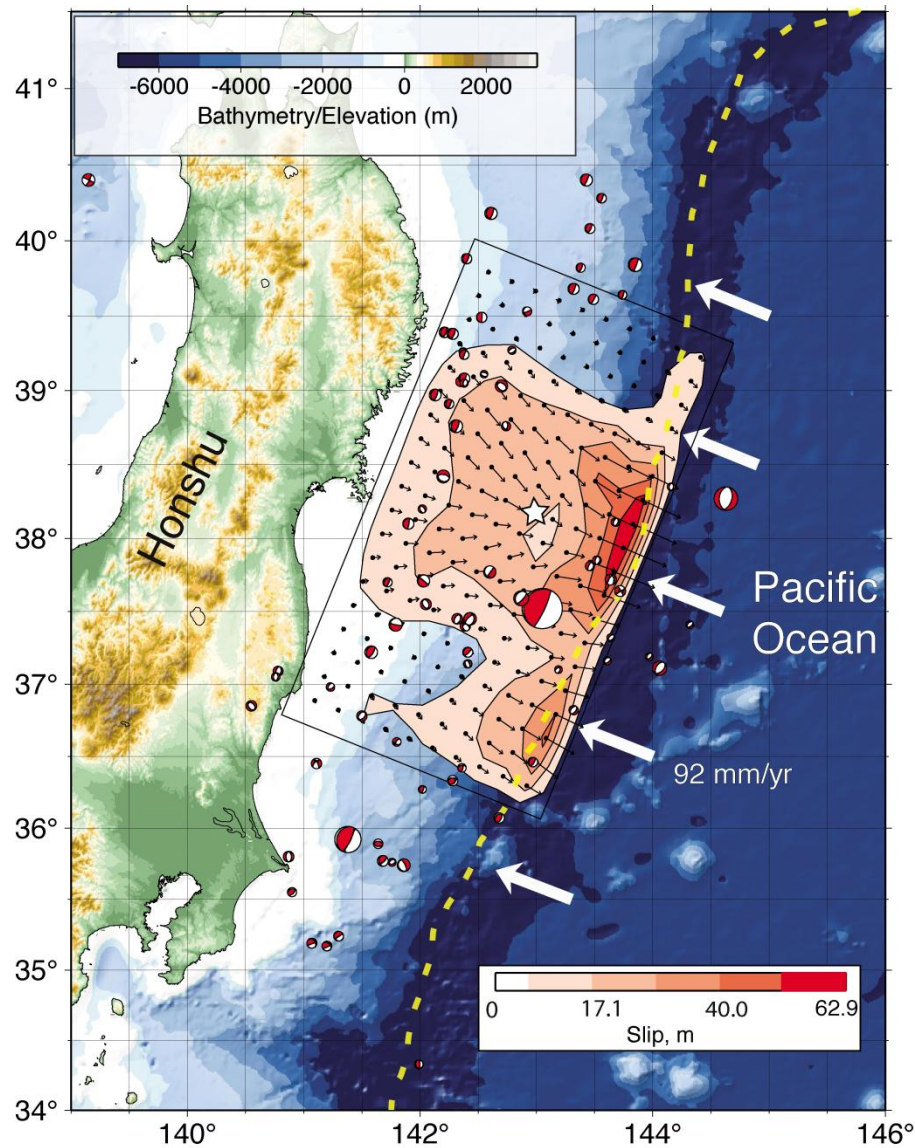

Telesismic waveforms analysis
Lay et al. (2011)

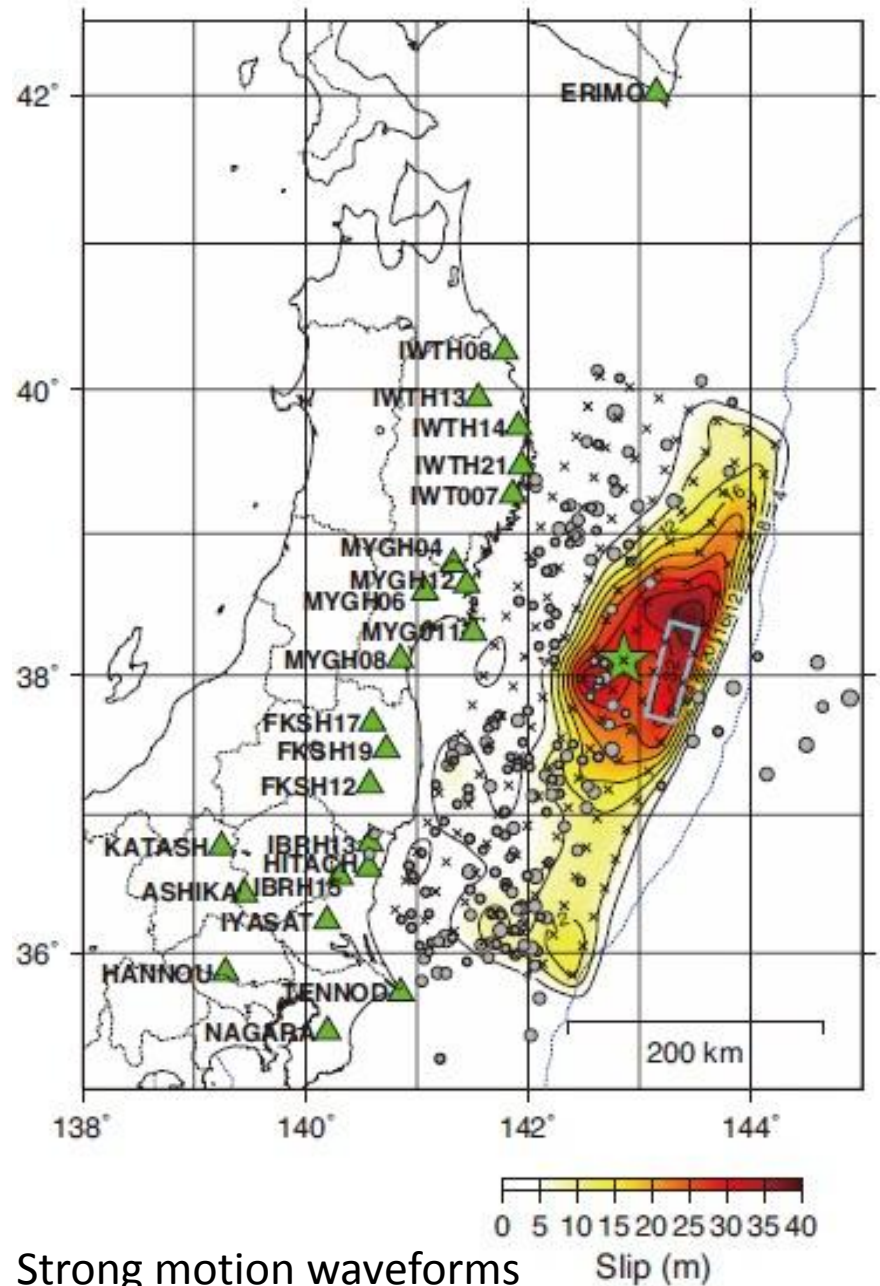

Strong motion waveforms
Yoshida et al. (2011)

Vertical deformation computed from the estimated slip distribution

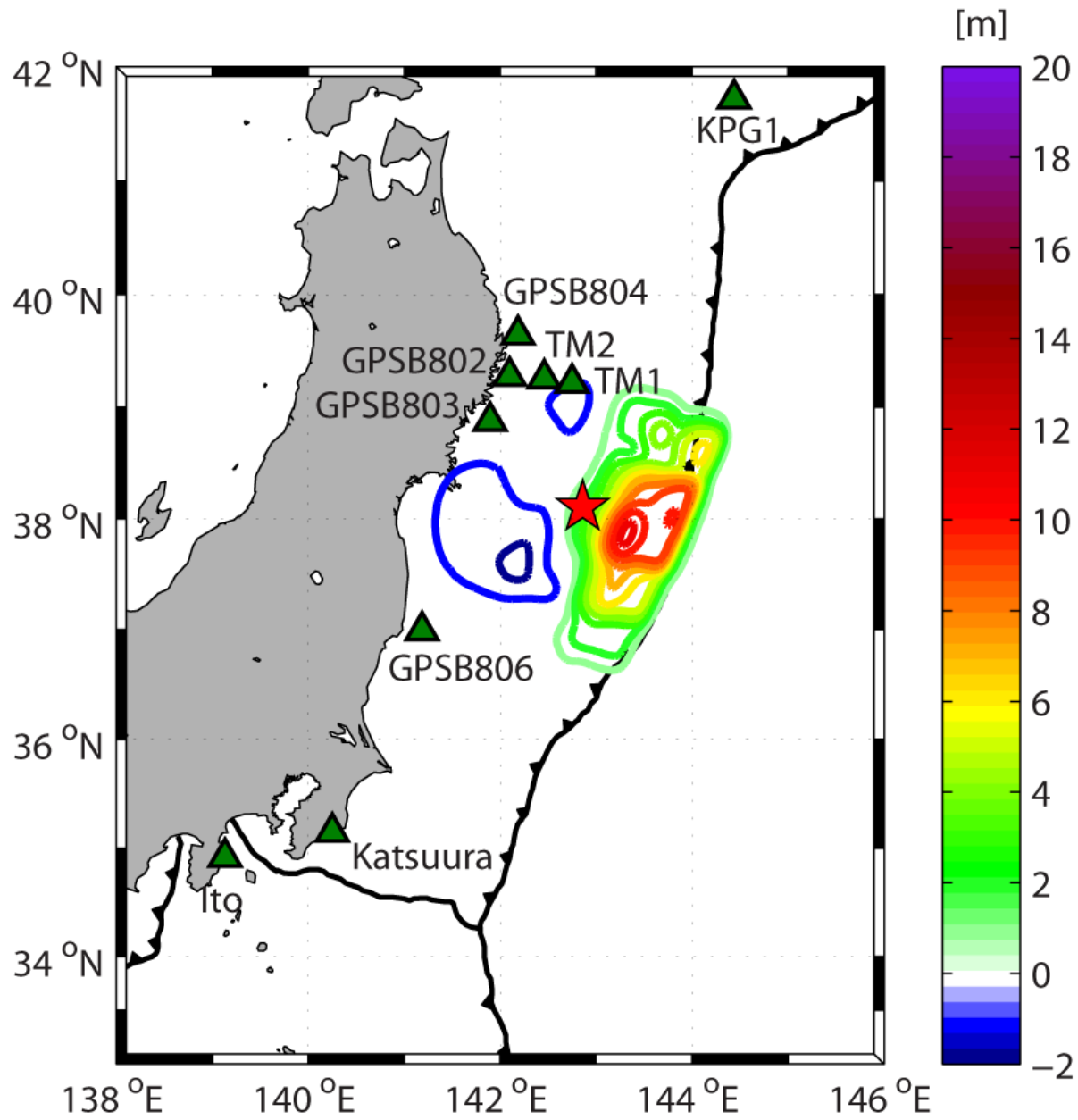

Comparison of observed and computed tsunami waveforms

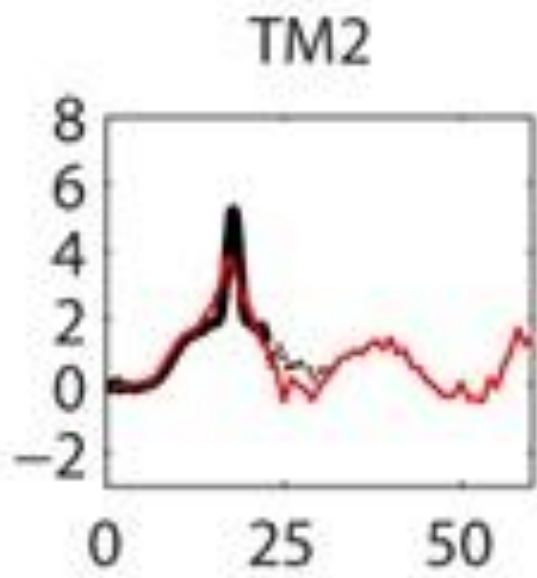
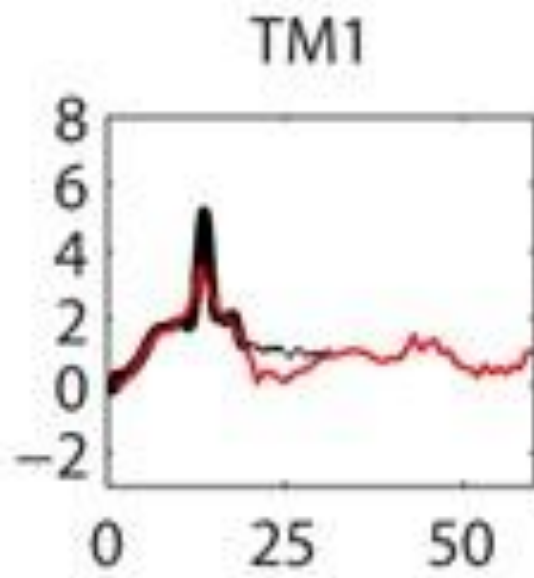
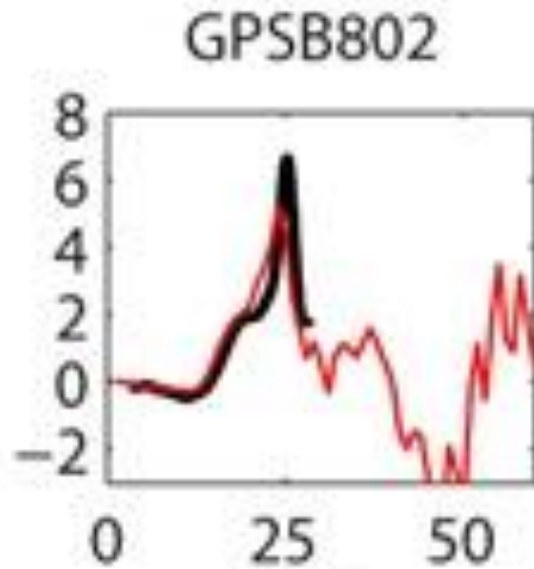

Time, min

Additional uplift model in the accretionary prism near the trench
(Tanioka and Seno, 2001)

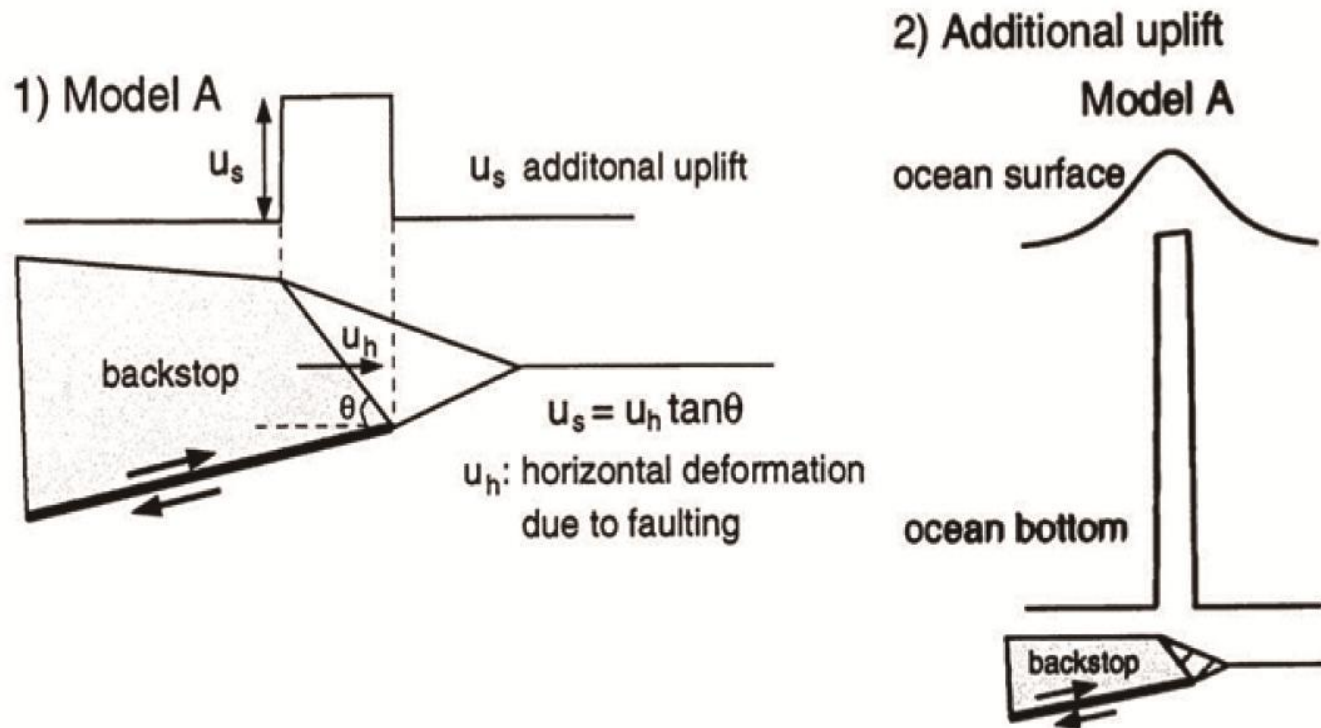

Model A for the 1896 Sanriku tsunami earthquake used by Tanioka and Seno (2001).

Horizontal deformation was estimated from slip distribution.

$\theta=50^\circ$, width 1.5km

Vertical deformation computed from the estimated slip distribution

a) Only from slip distribution

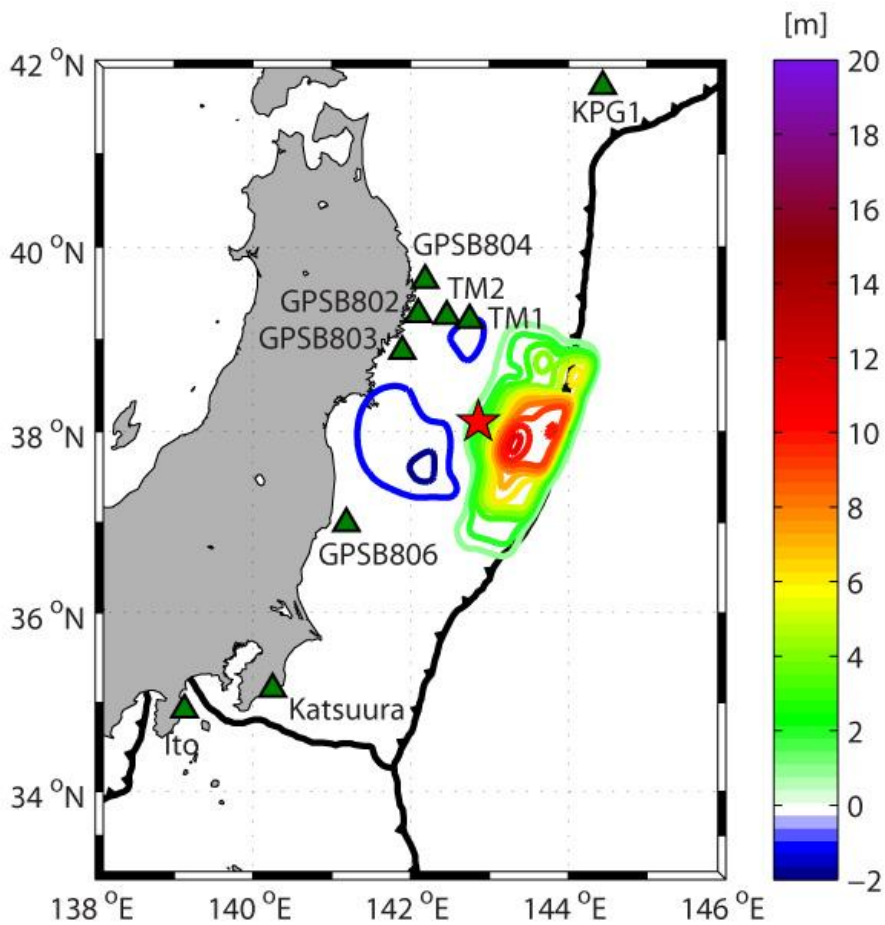

b) With additional uplift

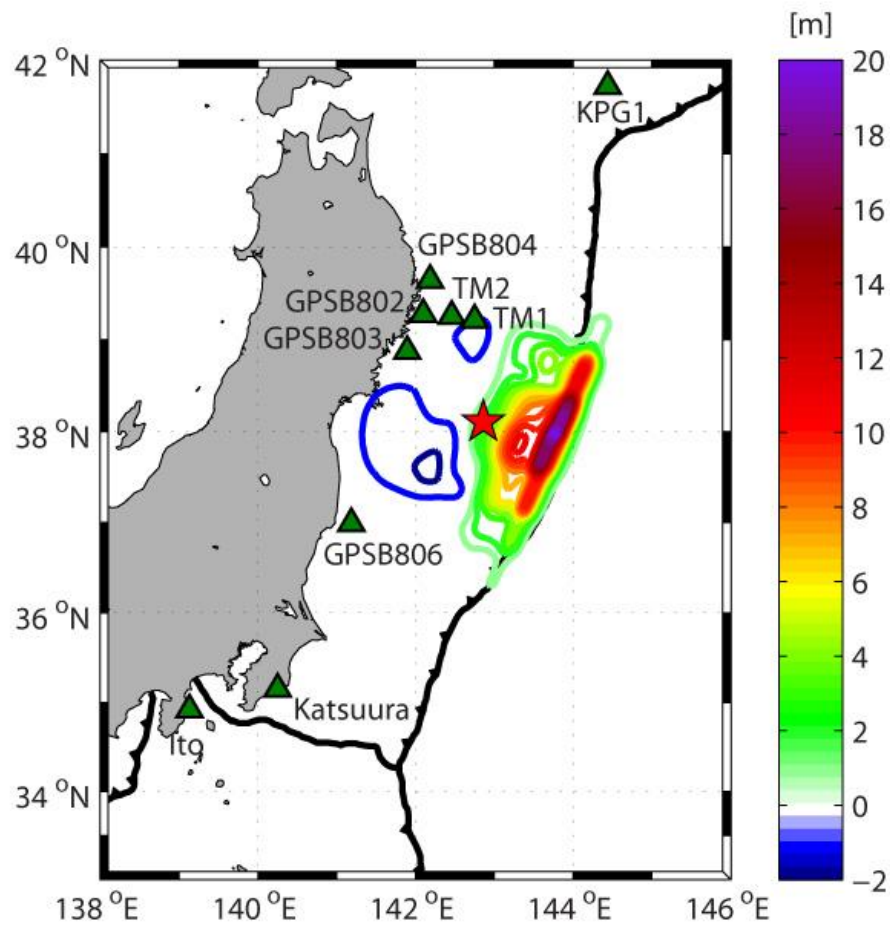

観測津波波形と計算津波波形の比較

GPSB802

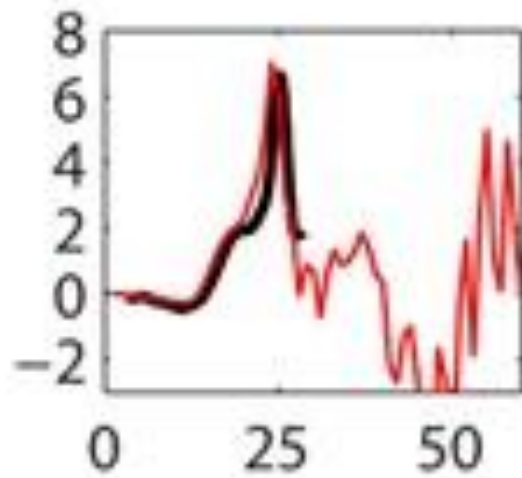

TM1

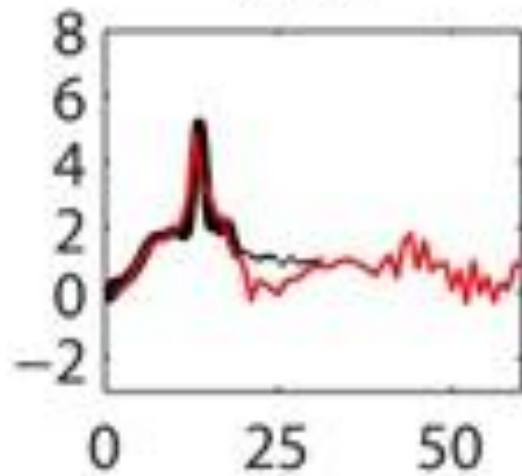

TM2

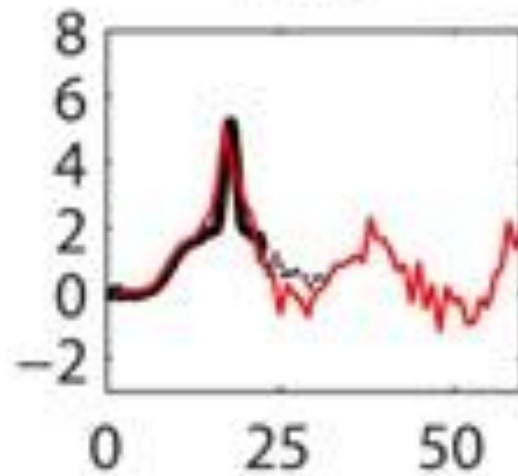

50 100
Time, min

10 min

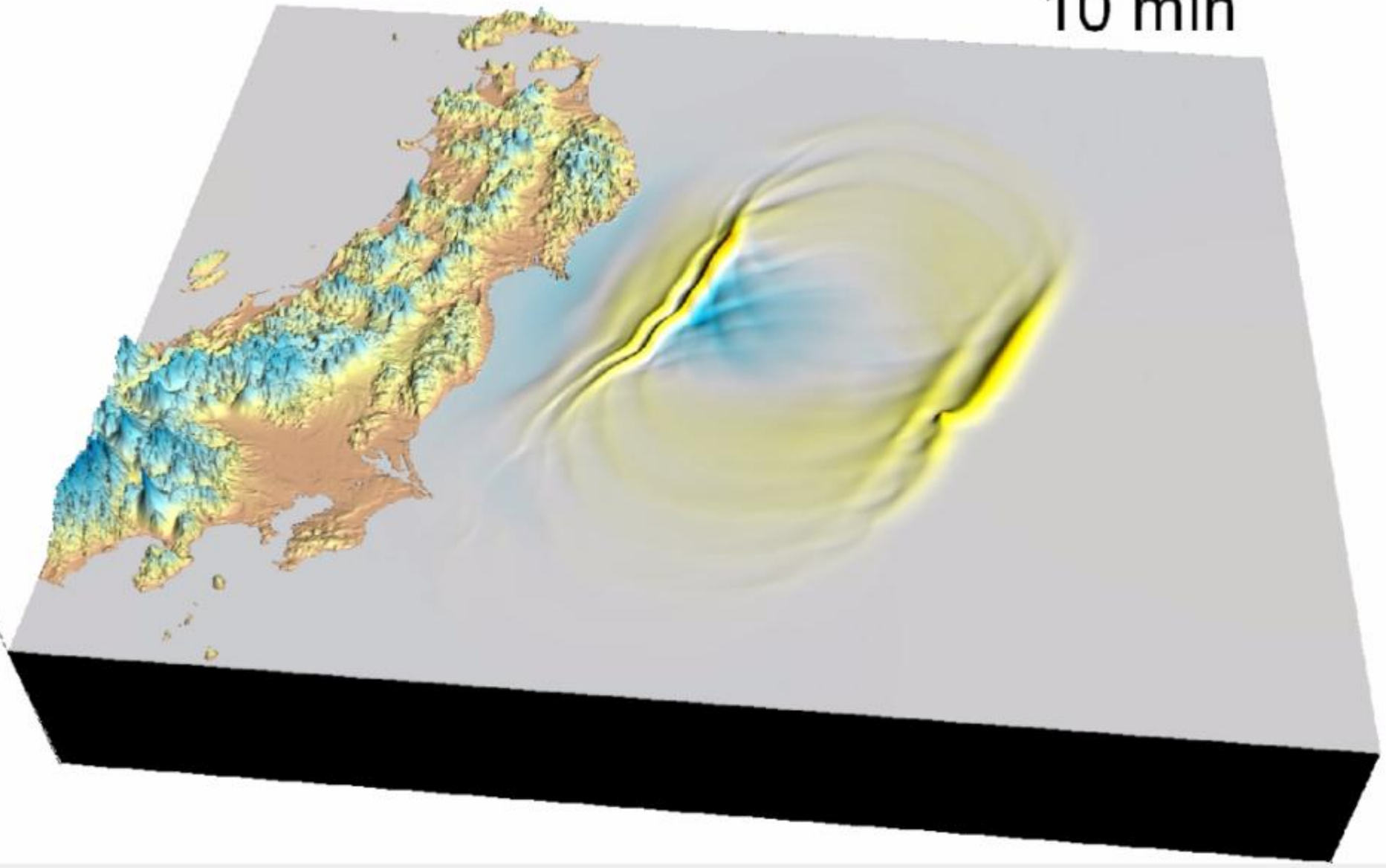

75 min

Sendai Airport

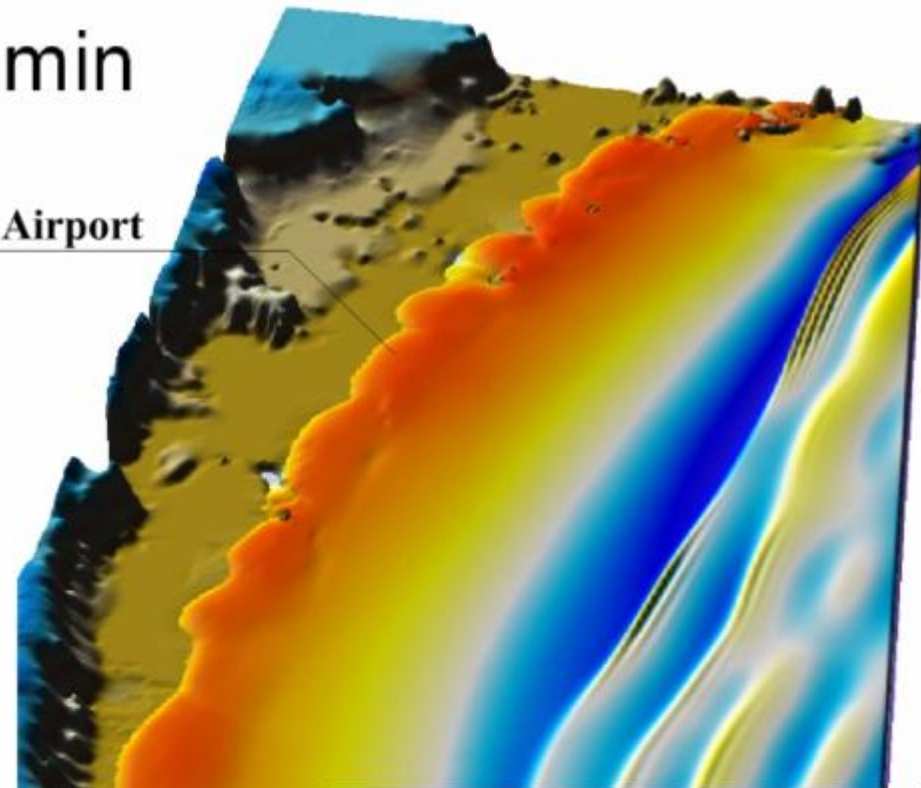
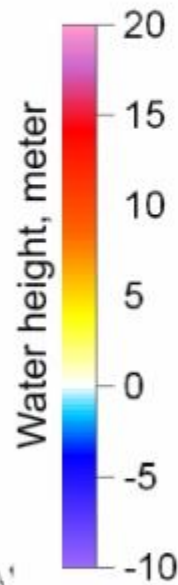

台空港が浸水 1 (全) 15:57:40

Survey data for the 2011 Tohoku-oki tsunami (The Joint Survey Group in Japan)
(More than 3000 points)

05-Jul-2011

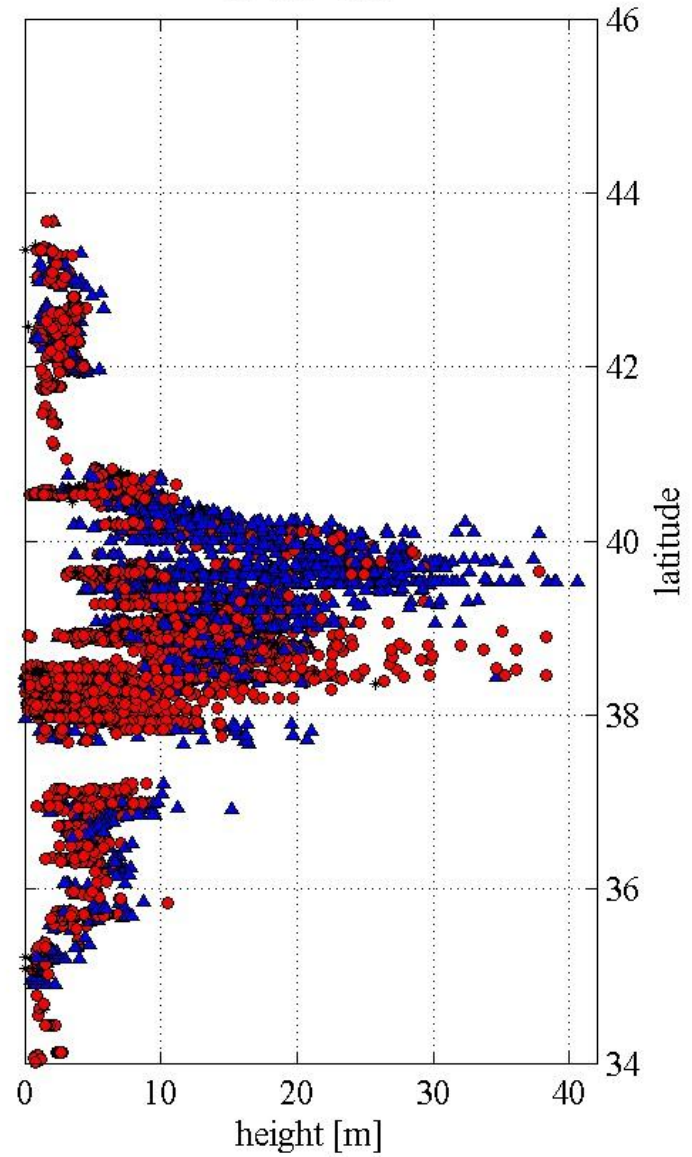
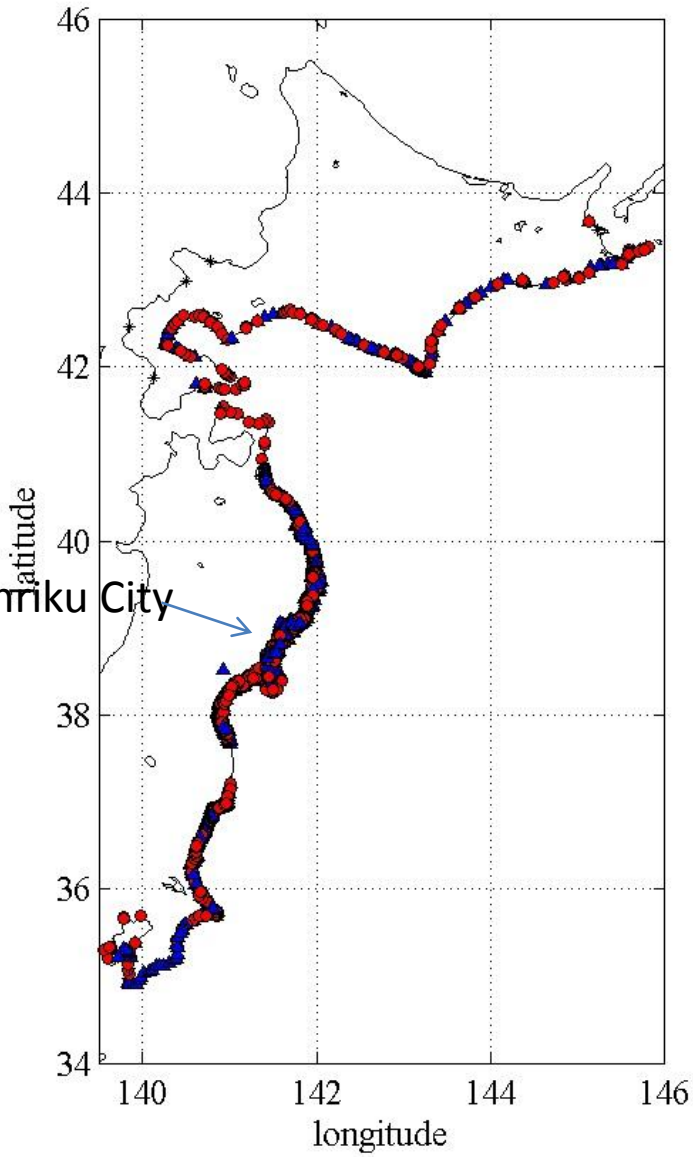

red : tsunami inundation height

blue: run-up heights

Observed tsunami inundation area at Minami-Sanriku

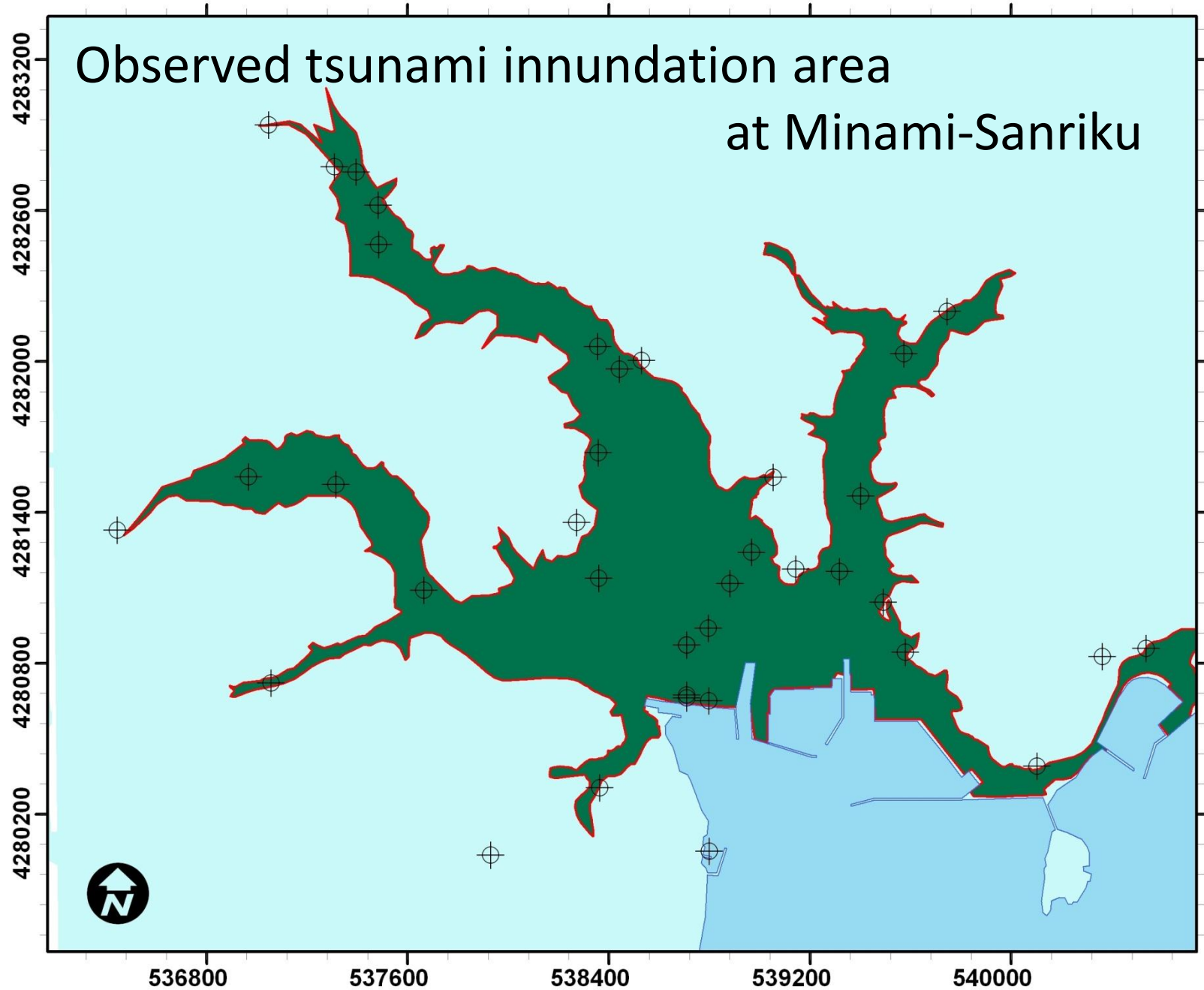



Minami-Sanriku (Aug. 5th, 2009)



Tsunami inundation computation result at Minami-Sanriku

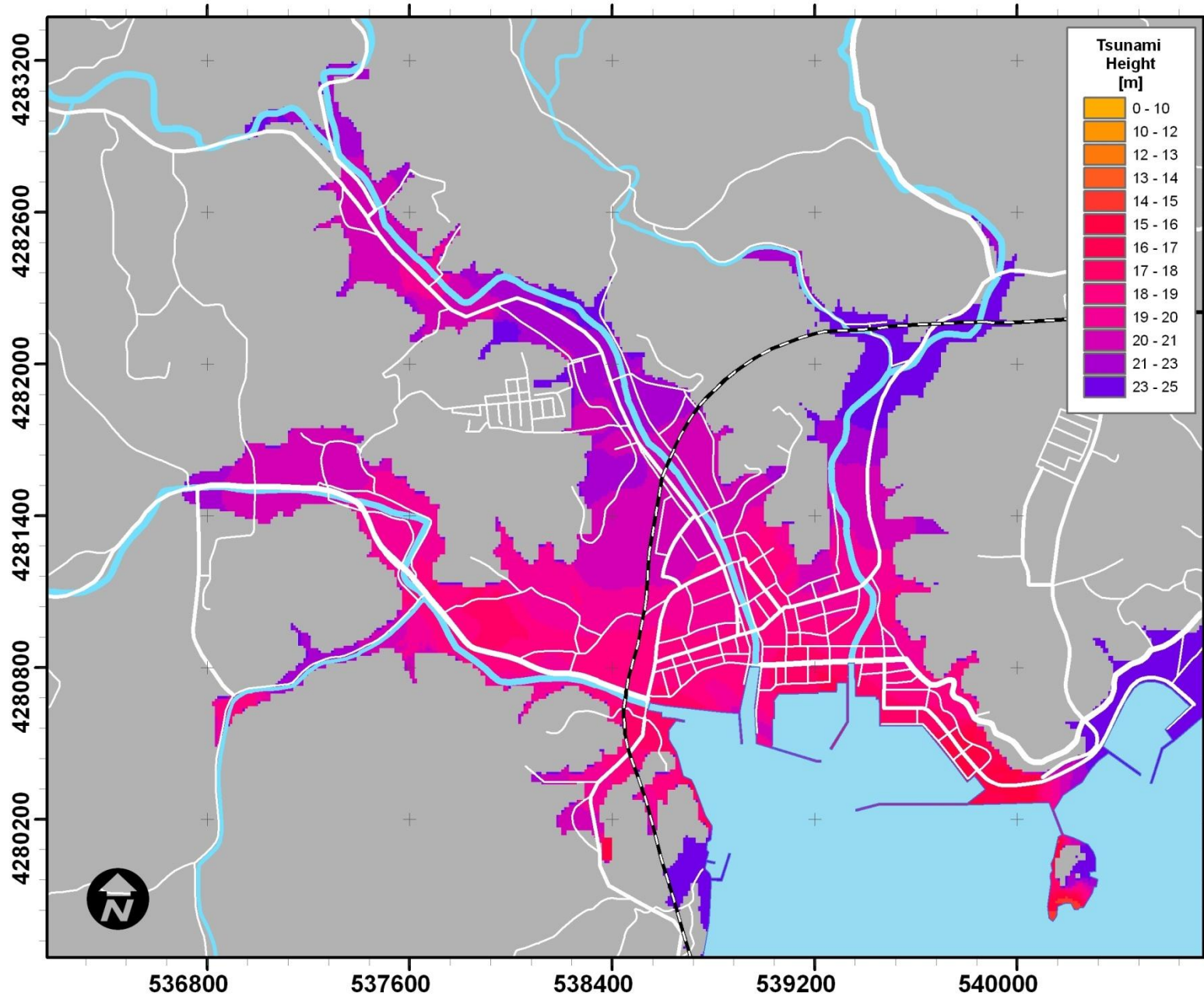

Comparison of observed and computed tsunami inundation area

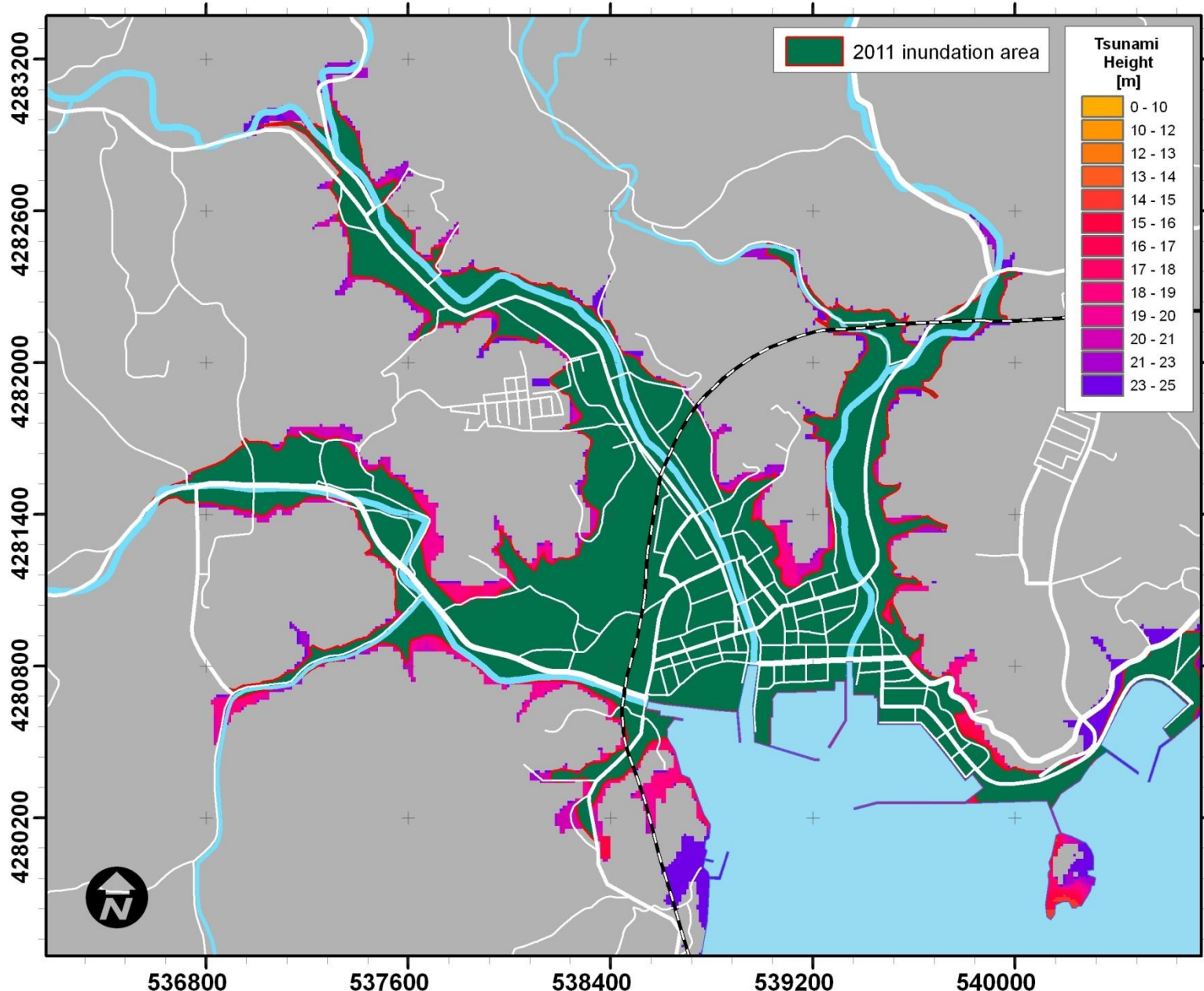

Comparison of observed and computed tsunami run-up heights

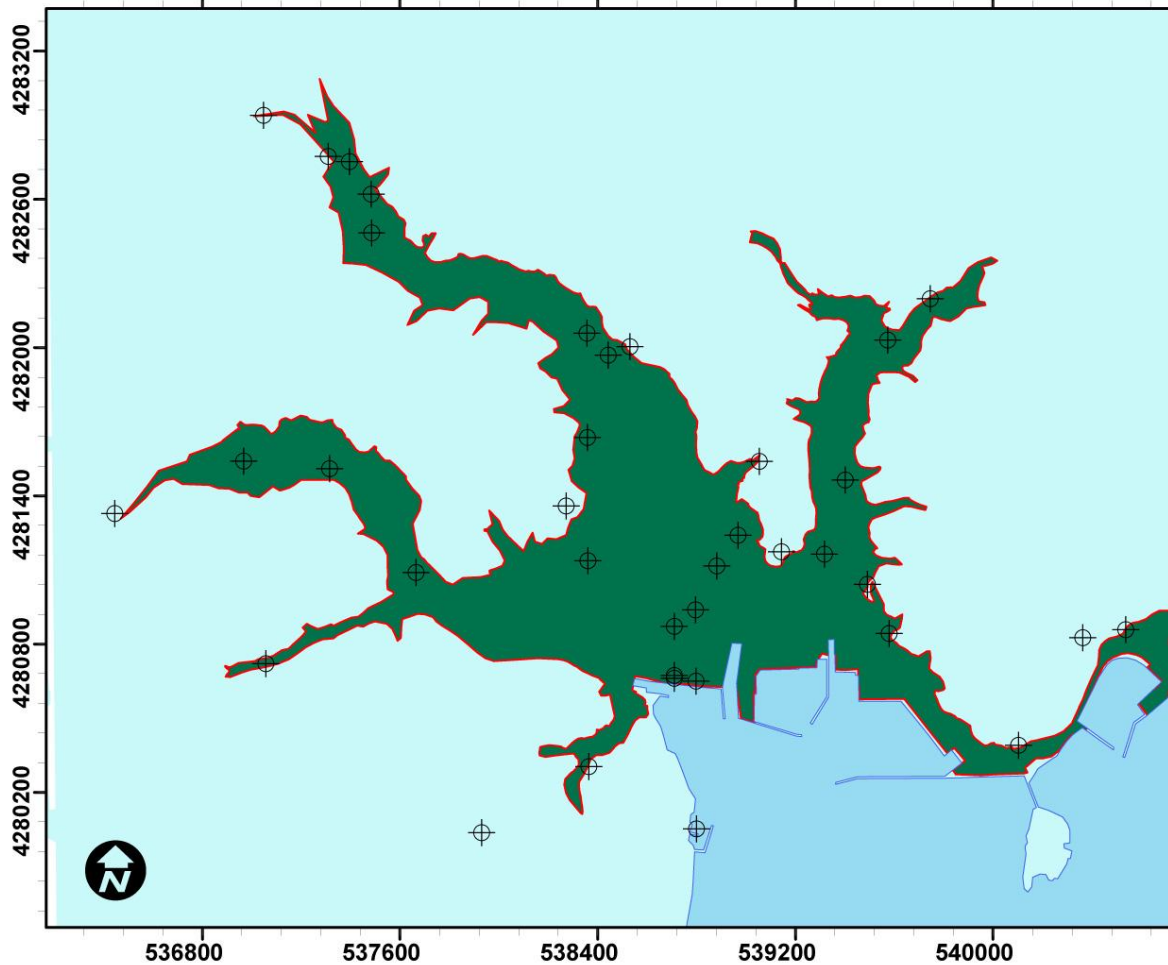
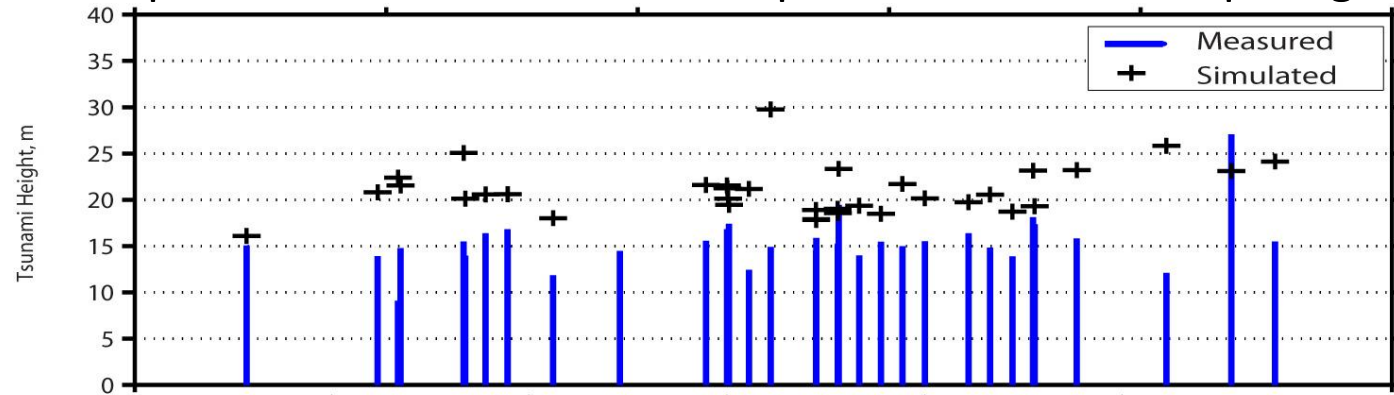

Slip distribution estimated using the joint inversion of co-seismic crustal deformation and

a) tsunami waveforms

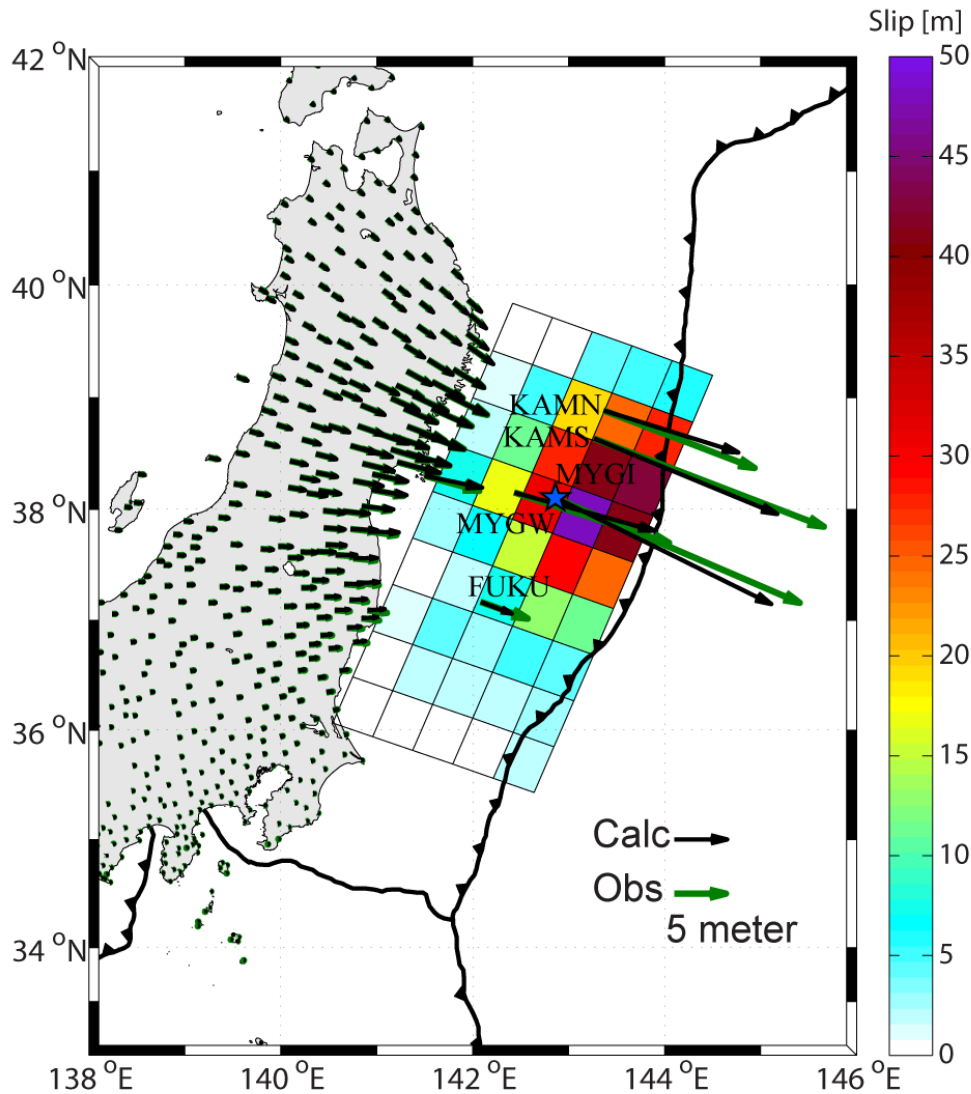

b)

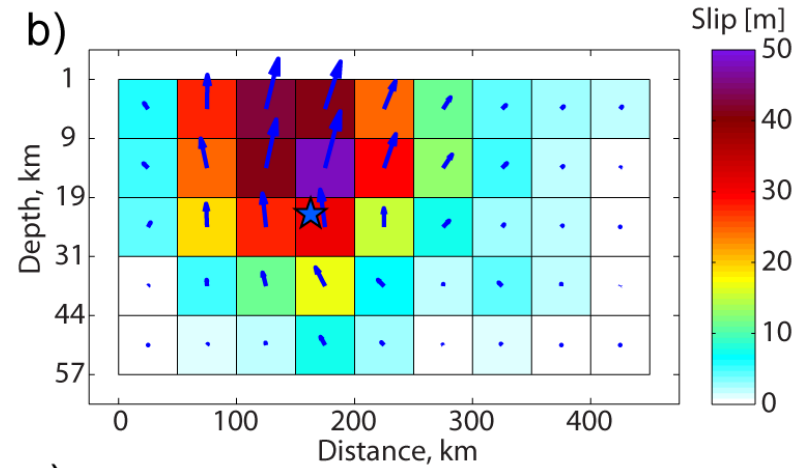

c)

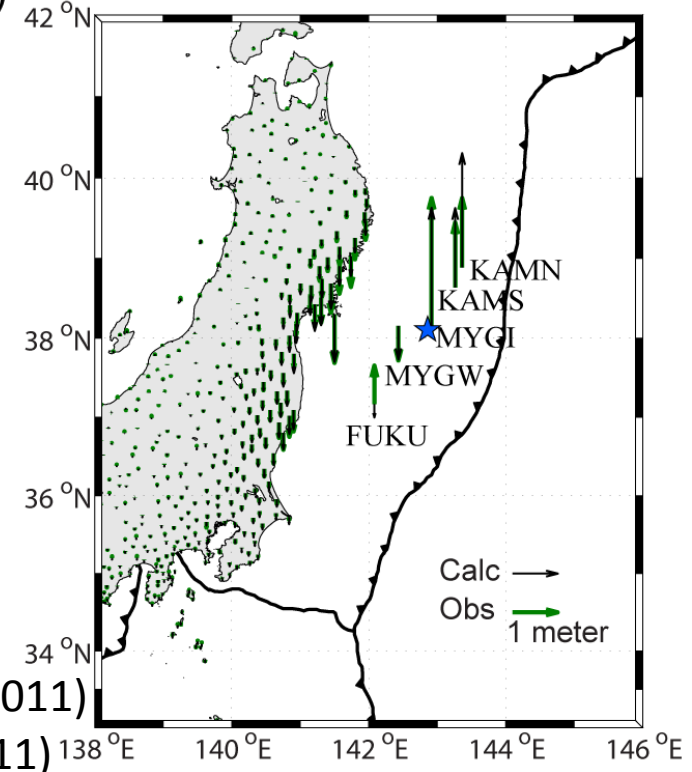

Co-seismic deformation observed by GPS (Ozawa et al., 2011)

Co-seismic deformation at ocean bottom (Sato et al., 2011)

Past Tsunami in Taro, Miyako city

1896 Meiji tsunami: 1867 deaths (out of 2248 residents, or 83%)

1933 Showa tsunami: 972 deaths (out of 4945, or 20%)

2011 Tohoku-oki tsunami: 230 casualties (out of 4000, or 6%)



10m high 2.5 km long breakwater around Town

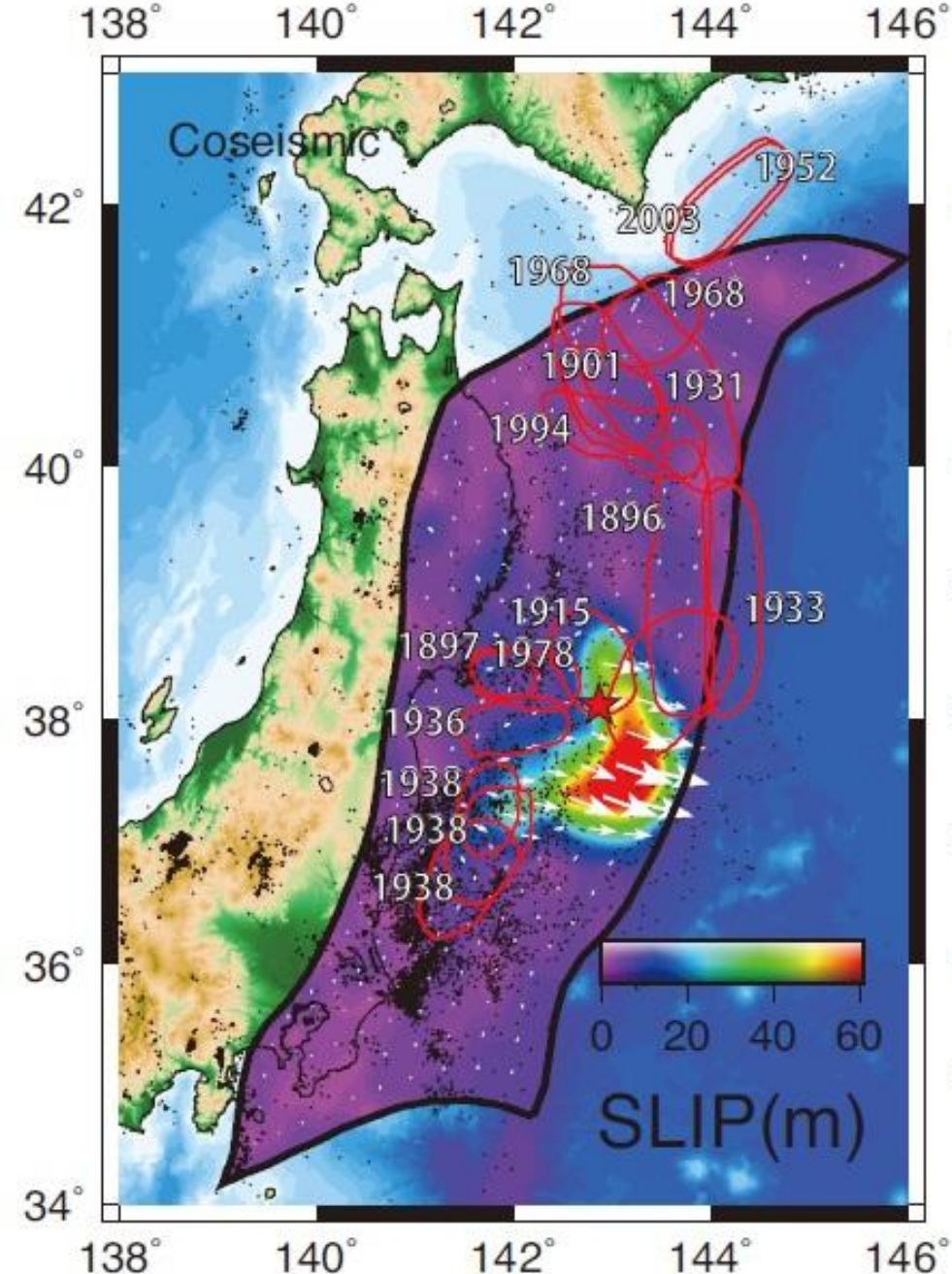

GPS data and seafloor deformation data Ito et al. (2011)

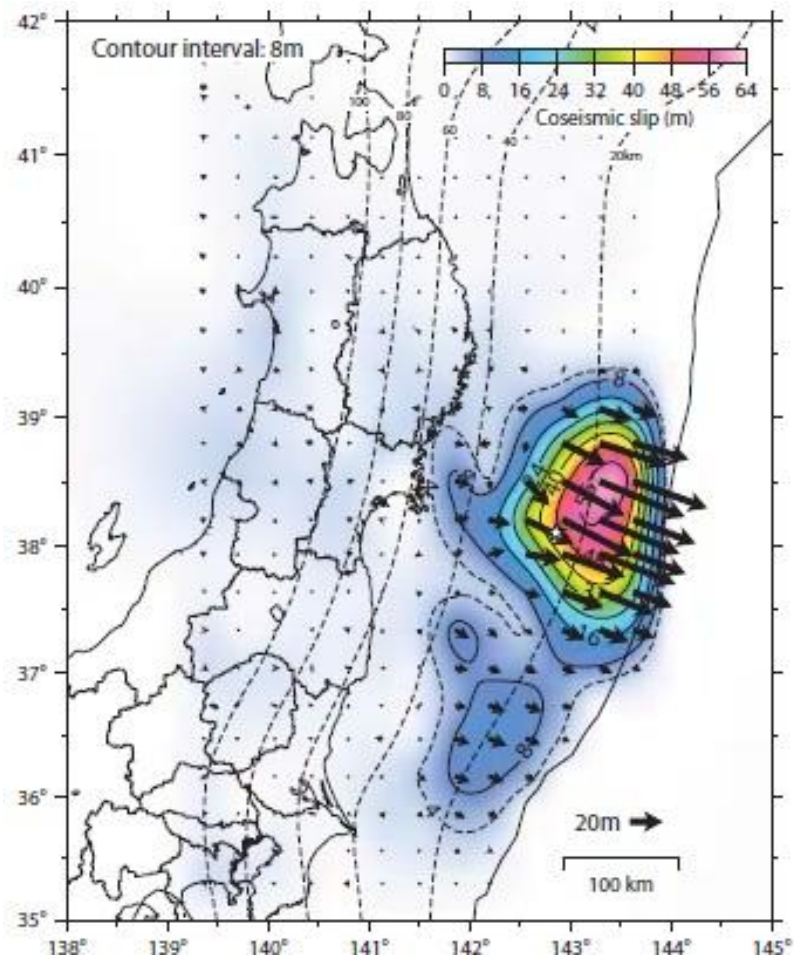

GPS data and seafloor deformation data
GIS Japan HP

南三陸町の津波遡上計算結果 (浸水深)

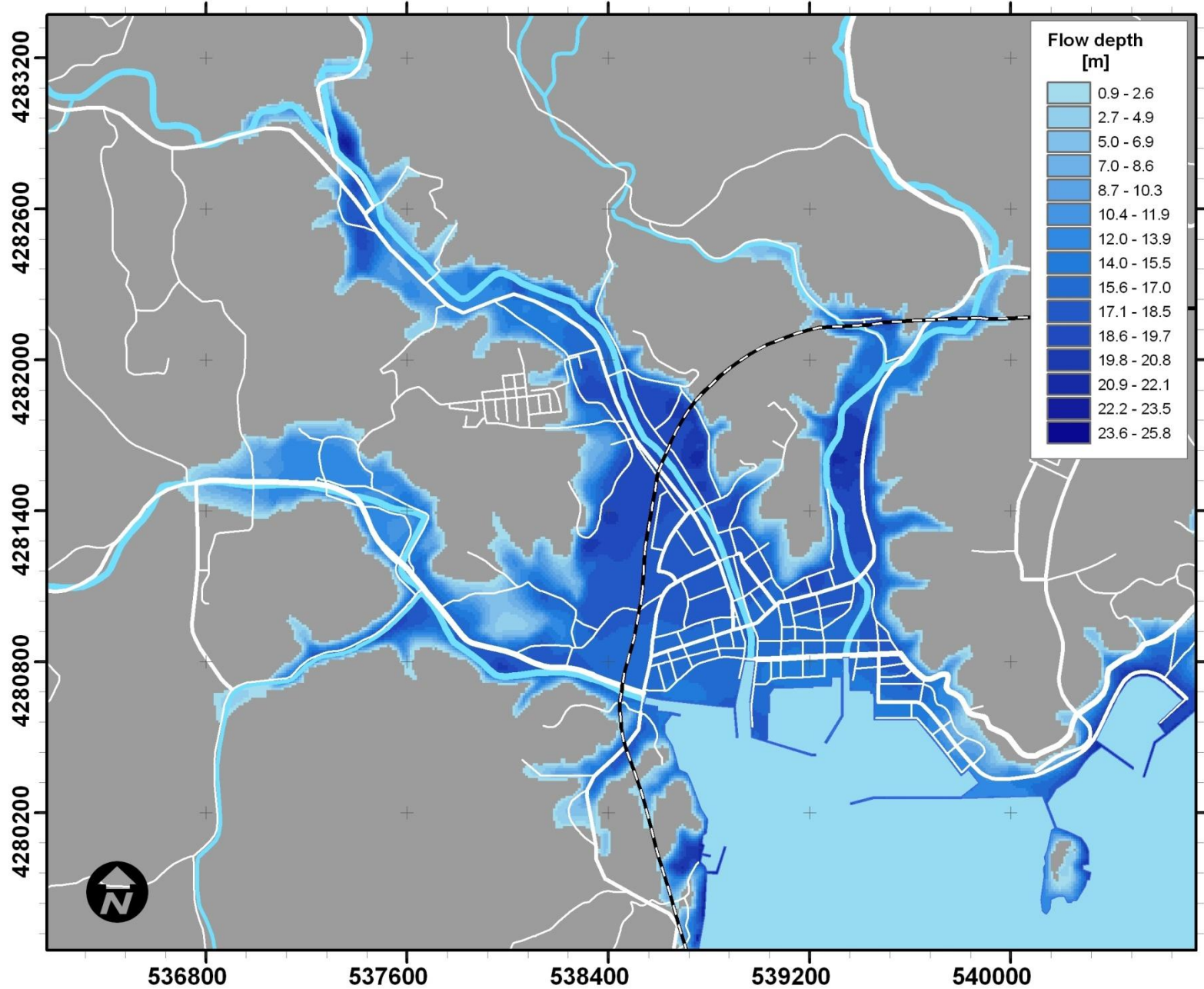

- 今後、陸前高田・田老町や宮古など、多くの主要被災地で数値計算を行い実際のデータとの比較を行うことで震源モデルの評価を実施する。